

**3.3 GHz Portable
Spectrum Analyzer
HM5033**







Before Starting to Use the Unit

When you use the unit, please observe the following notes listed on the rear of the body.

WARNING

**NO OPERATOR SERVICEABLE PARTS INSIDE .
REFER SERVICING TO QUALIFIED PERSONNEL .
PRIOR TO USE , BE FAMILIAR WITH SAFETY
INSTRUCTIONS IN THE MANUAL .**

CAUTION

**FOR CONTINUED FIRE PROTECT , REPLACE ONLY
WITH SPECIFIED TYPE 'S AND RATED FUSE .**

For you to use it safely

- 1) When abnormal sounds, abnormal smell and smoke were confirmed, remove the battery and AC adapter and stop the use.
- 2) Never use with hands that got wet, because doing so may cause damage, fire and electric shock to the unit.
- 3) Never use it under the thunder. There is a possibility of receiving a thunderbolt.
- 4) Never use an AC adapter other than the one specified, because doing so may cause damage to the unit. For static electricity protection, ground the unit by connecting the three cores if possible. Not grounding the unit can damage it and the object measured.
- 5) Never use a battery other than the one specified, because doing so may cause damage to the unit. When removing or installing the battery, be sure to do it after you turn off the unit and disconnect the AC adapter.
- 6) When replacing the fuse, disconnect the AC adapter, open the battery cover on the back and remove battery, and then take sufficient care to perform the replacement. Use 5 A / 250 V fuse (IEC127-2 sheet 3, slow-blow type).

Never use a fuse not specified because doing so may cause damage to the unit.

Guarantee of quality

Guarantee period

Guarantees that it will repair any failure free of charge if it occurs because of our responsibility within one year after delivery. However, the above guarantee does not apply to such a failure that:

- 1) is caused by a fire, natural disasters, etc.
- 2) is caused by inappropriate handling of the unit, such as dropping it while moving it after purchasing.

3) is caused by handling counter to the instructions or precautions listed in the operating manual.

4) is caused by modifying the unit or by being considered to be your responsibility because of inappropriate use.

We will not be responsible for direct or indirect damage caused by use of this product or by a failure of this product.

Warm-up time

In order to stabilize the electric performance at the time of turning on the unit, please perform warming-up for at least 10 minutes.

Precautions for storage

- 1) Strictly observe the storage conditions specified for this unit, such as avoiding direct sunlight and dust.
- 2) Store this unit in a place where $-20\text{ }^{\circ}\text{C}$ to $60\text{ }^{\circ}\text{C}$, less than $60\text{ }^{\circ}\text{C} / 70\text{ \%RH}$, variations in temperature and humidity are small.

After service

If you have any question about the contents of this product or how to operate it, please contact us at:

HAMEG GmbH

Industriestr. 6
D-63533 Mainhausen
Tel.: ++49 (0) 6182 89090
URL: <http://www.hameg.de>
E-mail: info@hameg.de



Herstellers
Manufacturer
Fabricant

HAMEG GmbH
Kelsterbacherstraße 15-19
D - 60528 Frankfurt

KONFORMITÄTSERKLÄRUNG
DECLARATION OF CONFORMITY
DECLARATION DE CONFORMITE

HAMEG[®]
Instruments

Die HAMEG GmbH bescheinigt die Konformität für das Produkt
The HAMEG GmbH herewith declares conformity of the product
HAMEG GmbH déclare la conformité du produit

Bezeichnung / Product name / Designation:
Spektrum-Analysator/Spectrum Analyzer/Analyseur de spectre

Typ / Type / Type: **HM5033**

mit / with / avec: -

Optionen / Options / Options: -

mit den folgenden Bestimmungen / with applicable regulations / avec les directives suivantes

EMV Richtlinie 89/336/EWG ergänzt durch 91/263/EWG, 92/31/EWG
EMC Directive 89/336/EEC amended by 91/263/EWG, 92/31/EEC
Directive EMC 89/336/CEE amendée par 91/263/EWG, 92/31/CEE

Niederspannungsrichtlinie 73/23/EWG ergänzt durch 93/68/EWG
Low-Voltage Equipment Directive 73/23/EEC amended by 93/68/EEC
Directive des équipements basse tension 73/23/CEE amendée par 93/68/CEE

Angewendete harmonisierte Normen / Harmonized standards applied / Normes harmonisées utilisées

Sicherheit / Safety / Sécurité
EN 61010-1: 2001 / IEC (CEI) 1010-1: 2001

Messkategorie / Measuring category / Catégorie de mesure: I
Verschmutzungsgrad / Degree of pollution / Degré de pollution: 2

Elektromagnetische Verträglichkeit / Electromagnetic compatibility / Compatibilité électromagnétique

EN 61326-1/A1 :1997 + A1:1998 + A2 :2001/IEC 61326 :1997 + A1 :1998 + A2 :2001
Störaussendung / Radiation / Emission: Tabelle / table / tableau 4; Klasse / Class / Classe B.
Störfestigkeit / Immunity / Imunité: Tabelle / table / tableau A1.

EN 61000-3-2/A14
Oberschwingungsströme / Harmonic current emissions / Émissions de courant harmonique: Klasse / Class / Classe D.

EN 61000-3-3
Spannungsschwankungen u. Flicker / Voltage fluctuations and flicker / Fluctuations de tension et du flicker.

Datum / Date / Date
25.6.2003

Unterschrift / Signature / Signatur

G. Hübenett
Product Manager

General information regarding the CE marking

HAMEG instruments comply with the regulations of the EMC directive. The conformity test made by HAMEG is based on the actual generic- and product standards. In cases where different limit values are applicable, HAMEG applies the severer standard. For emission the limits for residential, commercial and light industry are applied. Regarding the immunity (susceptibility) the limits for industrial environment have been used.

The measuring- and data lines of the instrument have much influence on emission and immunity and therefore on meeting the acceptance limits. For different applications the lines and/or cables used may be different. For measurement operation the following hints and conditions regarding emission and immunity should be observed:

1. Data cables

For the connection between instruments resp. their interfaces and external devices, (computer, printer etc.) sufficiently screened cables must be used. Without a special instruction in the manual for a reduced cable length, the maximum cable length of a dataline must be less than 3 meters and not be used outside buildings. If an interface has several connectors only one connector must have a connection to a cable.

Basically interconnections must have a double screening. For IEEE-bus purposes the double screened cables HZ72S and HZ72L from HAMEG are suitable.

2. Signal cables

Basically test leads for signal interconnection between test point and instrument should be as short as possible. Without instruction in the manual for a shorter length, signal lines must be less than 3 meters and not be used outside buildings.

Signal lines must be screened (coaxial cable - RG58/U). A proper ground connection is required. In combination with signal generators double screened cables (RG223/U, RG214/U) must be used.

3. Influence on measuring instruments.

Under the presence of strong high frequency electric or magnetic fields, even with careful setup of the measuring equipment an influence of such signals is unavoidable.

This will not cause damage or put the instrument out of operation. Small deviations of the measuring value (reading) exceeding the instruments specifications may result from such conditions in individual cases.

4. RF immunity of Spectrum Analyser

4.1 Electromagnetic RF field

Although the interior of the spectrum analyser is screened by the cabinet, the influence of electromagnetic RF fields may become visible, if the field intensity under the present environmental condition is high. The device under test as well as the measuring cable may also receive such signals.

HAMEG GmbH



1. Outlines	8	16. Calculation Function <CALC>	18
1.1 Product outlines	8	16.1 NORM mode	18
1.2 Standard accessories	8	16.2 MAX HOLD mode	18
1.3 Optional accessories	8	16.3 MIN HOLD mode	19
2. Specifications	8	16.4 AVERAGE mode	19
2.1 Performances	8	16.5 OVER WRITE mode	19
2.2 Outline	10	17. Marker · Peak Search <MKR>	19
3. Description of Panel	10	17.1 Moving the marker	19
4. Description of Screen	11	17.2 Setting the peak search	19
5. Function Key Menu	12	<PEAK SEARCH>	
5.1 List of the function key menus	12	17.3 Changing the unit of marker point	19
5.2 Menu tree	12	18. Save/Load <SAVE/LOAD>	19
6. Preparing for Operation	14	18.1 Setting the location to store the trace	19
6.1 Stand	14	18.2 Setting the location to store the parameter	20
6.2 Connection to power supply	14	18.3 Saving the data	20
6.3 Replacing the fuse	14	18.4 Loading the data	20
6.4 Installing the battery	14	18.5 Clearing the loaded trace	20
6.5 Soft carrying case	14	18.6 Presetting (Initialization)	20
7. Center Frequency <FREQ>	15	19. Measuring Function <MEAS>	20
7.1 Setting with the step keys	15	19.1 Channel power measurement	20
7.2 Setting with the encoder	15	<Ch Power>	
7.3 Setting with the numeric keys	15	19.2 Adjacent channel leakage power measurement	21
7.4 According to the marker position	15	<Adj Ch Pw>	
8. Frequency Span 	15	19.3 Occupied frequency bandwidth measurement	22
9. Reference Level <REFER>	16	<Occ Bw>	
9.1 Setting the reference level	16	19.4 Electric field strength measurement	22
9.2 Switching units of amplitude axis	16	<E/F ANT>	
9.3 Reference level setting range for each unit	16	19.5 Magnetic field strength measurement	25
9.4 Relation between the reference level	16	<M/F PROBE> (optional)	
and ATT-AMP		20. Screen Control <DSPL>	26
9.5 Setting the offset level	16	20.1 Adjusting the contrast	26
9.6 Setting the input impedance	17	20.2 Switching ON and OFF the LCD backlight	26
10. Display Scale <SCALE>	17	20.3 Adjusting the brightness of the LCD backlight	26
10.1 Setting with the keys	17	20.4 Inverting the display	26
10.2 Setting with the encoder	17	20.5 Enable or disabling the beep	26
11. Resolution Bandwidth <RBW>	17	21. Printing <PRINT> (optional)	26
11.1 MANUAL mode	17	21.1 Hard copy of the screen	26
11.2 AUTO mode	17	22. Data Output <RS232C>	26
11.3 ALL AUTO mode	17	22.1 Selecting the trace to transfer	26
12. Video Bandwidth <VBW>	17	22.2 Selecting the communication speed (baud rate)	26
12.1 MANUAL mode	17	22.3 Transfer the data	26
12.2 AUTO mode	17	23. RS-232C Interface	28
12.3 ALL AUTO mode	18	23.1 RS-232C specifications	28
13. Sweep Axis · Detection mode <SWEEP>	18	23.2 How to connect	28
13.1 MANUAL mode	18	23.3 Command description	28
13.2 AUTO mode	18	23.4 Input the frequency	28
13.3 ALL AUTO mode	18	23.5 Writing of original correction data	28
13.4 Setting the detection mode	18	23.6 Sample Programs	32
14. AUTO Tuning <AUTO TUNE>	18	24. PC Software (optional)	32
15. Hold/Run <HOLD/RUN>	18	25. Basis Performance Test	33
		25.1 Frequency characteristics	33
		25.2 Accuracy of reference level	35
		25.3 The display accuracy of the center frequency	35
		25.4 The display accuracy of the frequency span	35
		25.5 Linearity of the amplitude axis	36

Outlines

1. Outlines

1.1 Product outlines

HM5033 is an authentic spectrum analyzer providing performance and functions that are comparable to those of large-size bench type equipment, in a compact, lightweight and inexpensive model.

1) Compact and lightweight, 1.7 kg

The external dimensions are as small as 162 (W) × 70 (H) × 260 (D) (mm), and the weight is only 1.7 kg including the battery. It is very convenient for outdoor use and while on business trips.

2) Measuring frequency bandwidth 50 kHz to 3.3 GHz

This bandwidth covers those of W-CDMA, CDMA, PDC, PHS, GSM, 2.4 GHz band wireless LAN, Bluetooth, etc.

3) Operation with battery for 120 minutes

When battery MB300 is fully charged, HM5033 works for about 120 minutes (with the backlight turned off). It is extremely convenient for outdoor use and for use in the survey of wireless LAN installation environment.

4) Performance that is comparable to that of large-size bench type equipment

HM5033 guarantees a highly stable frequency axis by PLL synthesizer system. The center frequency setup resolution is 100 kHz. Furthermore, the mean noise level is -110 dBm or less. Thus, a broad dynamic range is secured and the reference level can be set in 1 dB steps.

5) Abundant functions

Measuring functions: Channel power measurement, Adjacent channel leakage power measurement, Occupied frequency bandwidth measurement, Electric field strength measurement.

Electric field strength measurement: Optimum for measurement of cellular phone and wireless LAN working environment.

Magnetic field strength measurement: Optimum for EMI design of printed circuit boards and for evaluation of signal quality.

Calculation functions: MAX HOLD, MIN HOLD, AVERAGE, OVER WRITE

Marker & peak search

Save/Load

6) Auto tuning

The center frequency is set at the spectrum of the maximum level in the 3.3 GHz band, and in addition, optimum reference level, resolution bandwidth, video bandwidth and sweep time are set when the AUTO TUNE key is pressed. This function is very convenient for measurement of an unknown signal.

7) Auto range motion

The resolution bandwidth, video bandwidth and sweep time are set automatically based on the set frequency span. It is also possible to set auto range motion only one out of resolution bandwidth, video bandwidth and sweep time.

8) Hard copy of the image

Connect a printer (optional) and press the [PRINT] key on HM5033. The image on the screen is printed as it is.

9) High resolution display on the PC screen

The trace is displayed at high resolution, 1001 points in the horizontal axis, on the PC screen when „PC Software MAS300“ (optional) is used.

1.2 Standard accessories

1. AC adaptor MA300
2. Soft carrying case
3. Accessory pouch
4. Operating manual
5. Ni-MH battery MB300 (Refer to „6.4 Installing the battery“ for details.)

1.3 Optional accessories

1. PC software MAS300 (Refer to „24. PC Software“ for details).
2. Electric field antenna M301, M302, M303, M304, M305 (Please note „19.4 Electric field strength measurement“).
3. Magnetic field probe CP-2S with a dedicated double shielded coaxial cable (Please note „19.5 Magnetic field strength measurement“).
4. Ni-MH battery MB300 (Refer to „6.4 Installing the battery“ for details).
5. Battery charger MBC300
6. Printer with AC adaptor, 4 pcs. of AA batteries and one paper roll (Please note „21. Printing“)
7. Paper pack (10 rolls)

2. Specifications

2.1 Performance

Frequency section

Frequency range: 50 kHz to 3.3 GHz

Center frequency

Setting resolution: 100 kHz, allows Rotary encoder, numeric key and function key

Accuracy (kHz): **within** $\pm(30 + 100 \times t) \pm 1$ dot
t: Sweep time (s)
(frequency span: 200 kHz to 10 MHz,
RBW: 30 kHz, 23 °C ± 5 °C)

within $\pm(100 + 700 \times t) \pm 1$ dot
t: Sweep time (s)
(frequency span: 20 MHz to 3.3 GHz,
RBW: 100 kHz, 23 °C ± 5 °C)

RBW frequency error: **within** ± 6 % of RBW
(RBW: 3 kHz, 30 kHz)
within ± 30 % of RBW
(RBW: 100 kHz to 3 MHz)

Frequency span		RBW switching error:	within ±0.6 dB
Setting range:	0 Hz (zero span), 200 kHz to 2 GHz (1-2-5step), 3.3 GHz (full span)	Display resolution:	0.4 dB (10 dB/div) 0.08 dB (2 dB/div)
Accuracy (kHz):	within [±3 % (20 x t)] ±1 dot (frequency span: 200 kHz to 10 MHz, 23 °C ±5 °C)	Display dot number:	200 dots
	within [±3 % ±(200 x t)] ±1 dot (frequency span: 20 MHz to 3.3 GHz, 23 °C ±5 °C) t: Sweep time (s)	Display Scale:	Scale: 10 dB / div, 2 dB/div
Display resolution:		Accuracy:	within ±0.2 dB / 2 dB ±1 dot
LCD:	Frequency span/250		within ±0.8 dB / 10 dB ±1 dot
PC Monitor (max.):	Frequency span/1000 (via RS-232C)		within ±1.6 dB / 70 dB ±1 dot
Display dot number:		Input damage level:	+20 dBm (CW average power), 25 VDC
LCD:	251 dots,	Sweep section	
PC Monitor (max.):	1001 dots (via RS-232C) (The unit displays data as 251 horizontal dots, but it internally captures the signal as in 1001 dots)	Sweep time	10 ms to 30 s (1-3step, frequency span: 0 to 2 GHz) and AUTO
Resolution bandwidth:	3 dB bandwidth	Setting range:	30 ms to 30 s (1-3step, frequency span: full span) and AUTO
Setting range:	3 kHz to 3 MHz (1-3step) and AUTO	Accuracy:	within ±0.1 % ±1 dot (frequency span: 0 to 2 GHz)
Accuracy:	within ±20 %		within ±1.5 % ±1 dot (frequency span: full span)
Selectivity:	1 : 12 (typical, 3 dB : 60 dB)	Trigger mode:	AUTO (frequency span: zero span)
Video bandwidth:	100 Hz to 300 kHz (1-3step), OFF and AUTO	Detection mode:	Positive peak, Negative peak, Sample (When sweep time is 10 ms or 30 ms, only Sample can be set)
SSB phase noise:	-90 dBc/Hz (typical, 100 kHz offset, RBW: 3 kHz, VBW: 100 Hz, Sweep time: 0.3 s)	Functions	
Spurious response:	less than -60 dBc	Marker:	
Harmonics:	less than -40 dBc (50 kHz to 100 MHz) less than -45 dBc (100 MHz to 3.3 GHz)	NORM:	displays frequency (7 digits max) and level (4 digits max) at marker point
Amplitude section		DELTA:	displays differential frequency and level between 2 markers.
Reference level		Peak search:	
Setting range:	+10 to -60 dBm (1dB step)	NORM:	searches a peak point within 10 div. Available NEXT peak (10 max).
Accuracy:	within ±0.8 dB ±1 dot (center frequency: 100 MHz, RBW: 3 MHz, VBW: 1 MHz, ATT: 0 dB, 23 °C ±5 °C)	ZONE:	searches a peak point within a zone designated by center and width. Marker moves to a peak point each sweep.
Unit:	dBm, dBV, dBmV, dBμV, dBμV/m, dBμA/m (dBμV/m and dBμA/m is used the measuring function)	Calculation:	NORM, MAX HOLD, MIN HOLD, AVERAGE, OVER WRITE
Average noise level:	-110 dBm (typical, center frequency: 100 MHz, RBW: 3 kHz, VBW: 100 Hz)	MAX/MIN HOLD:	2 to 1024 times
Frequency Characteristic:	within ±2.0 dB ±1 dot (50 kHz to 100 MHz) within ±1.0 dB ±1 dot (100 MHz to 3.3 GHz)	AVERAGE:	2 to 256
Input impedance:	50 Ω	Measuring:	Channel power, Adjacent channel leakage power, Occupied frequency bandwidth, Electric field strength (optional antenna), Magnetic field strength (needs optional magnetic field probe) measurement, Frequency counter.
Input VSWR:	less than 2.0		
Input attenuator:			
Operating range:	0 to 25 dB (1 dB step), coupled with reference level		
Switching error:	within ±0.6 dB		

Description of Panel

AUTO tuning:

When pushing AUTO TUNE key, the maximum level spectrum within 3.3 GHz bandwidth is adjusted to center, and reference level, RBW, VBW and sweep time are adjusted to optimum values.

Save/Load

Save: Saves 100 traces and 100 setups
Load: Loads 1 trace and 1 setup

General

Input connector: SMA(J)

Communication:

Interface: RS-232C
Baud rate: 2400 to 38400 bps

Hard copy: Allows direct hard copy with an optional printer.

Display: LCD
Backlight: CFL backlight
Resolution: 320 (H) × 240 (V) dots

Power source:

Battery: Ni-MH battery
External DC source: Pin jack, DC 5 V / 4 A

Other

Operating temperature: 0 °C to 40 °C
(Guaranteed at 23 °C ±10 °C, without soft carrying case)

Operating humidity: less than 40 °C / 80 % RH
(Guaranteed at less than 33 °C / 70 % RH, without soft carrying case)

Storage temperature: -20 °C to 60 °C,
less than 60 °C / 70 % RH

Dimensions (W x H x D): 162 × 70 × 260 mm

Weight: approx. 1.5 kg (without battery)

2.2 Outline

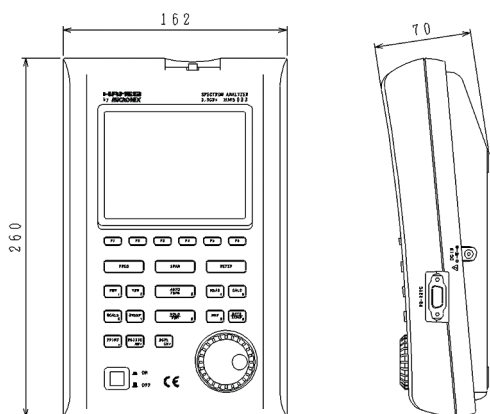

HAMEG & MICRONIX reserves the right to make changes in design, specification and other information without prior notice.

3. Description of Panel

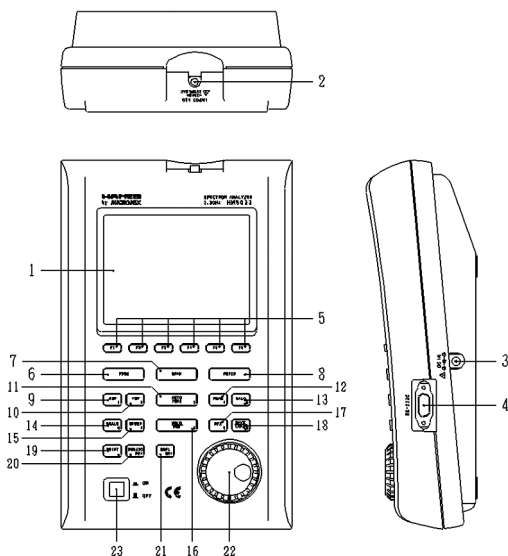

- 1) **LCD screen**
This is a large liquid crystal display with 240 (V) × 320 (H) dots. It simultaneously displays traces (8 × 10 div), various setting values, measured values, etc.
- 2) **Input connector**
SMA (J) connector.
- 3) **Input connector for DC power source**
Connects AC adaptor MA300.
- 4) **RS-232C connector**
Connects PC and printer, by using RS-232C cable MI180.
- 5) **Function keys (F1 to F6)**
Functions change according to operation. Have functions corresponding to the on-screen displays.
- 6) **Center frequency key**
Use this key to set the center frequency. It can set between 0 to 3.3 GHz (100 kHz step).
- 7) **Frequency span key**
Use this key to set the frequency span. It can set between 200 kHz to 2 GHz, ZERO SPAN and FULL SPAN (3.3 GHz).
- 8) **Reference level key**
Set the reference level, etc. Reference level can set between +10dBm and -60dBm (1dB step).
- 9) **Resolution bandwidth key**
Use this key to set the resolution bandwidth. It can set between 3 kHz and 3 MHz.
- 10) **Video bandwidth key**
Use this key to set the video bandwidth. It can set between 100 Hz and 1 MHz .
- 11) **AUTO tuning key**
Tune up to the maximum level in 3.3 GHz zones, and display by the optimal setup. This does not operate normally when the signal level is lower than -40 dBm , or when the input frequency is below 50 MHz, or when the frequency span is ZERO SPAN or FULL SPAN.

12) Measuring function key

Available for Channel power, Adjacent channel leakage power, Occupied frequency bandwidth, Electric field strength and Magnetic field strength measurement (optional), Frequency counter (factory option).

13) Calculation function key

Available for Max hold, Min hold, Average and Over write.

14) Display scale key

Use this key to select the display scale of amplitude axis from 2 dB/div or 10 dB/div.

15) Sweep key

Use this key to set the sweep time between 10 ms to 30 s or set the detection mode.

16) Hold/Run key

Stops or restarts the measurement.

17) Marker & Peak search key

Use this key to set and move a marker.

18) Save/Load key

Saves 100 traces and 100 setups, and loads 1 trace and 1 setup.

19) Print key

When pressing this key, the image is printed with a printer (optional) as it is.

20) RS-232C key

Sets baud rate and transfers a current or saved trace.

21) Display control key

Sets contrast, backlight ON/OFF, brightness of backlight, invert display and buzzer ON/OFF.

22) Rotary encoder

Use this to make various settings.

23) Power switch

Use this to turn the power ON or OFF.

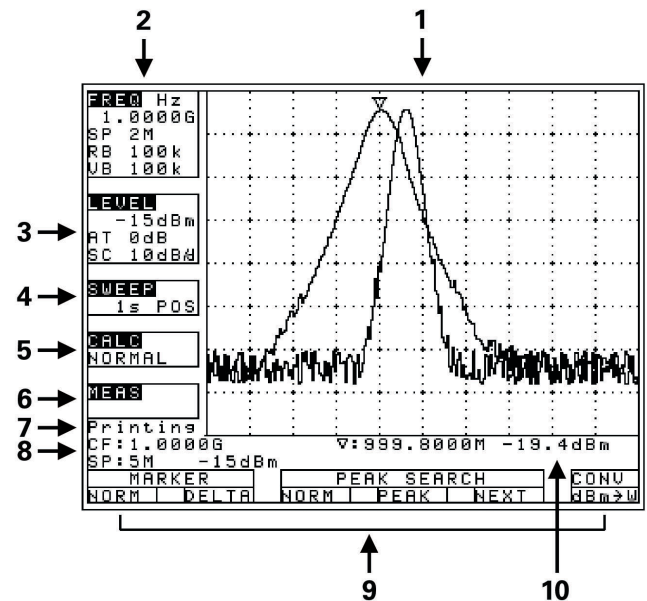
4. Description of Screen**1) Trace display**

8 div × 10 div.

2) Frequency axis setting values display

Center frequency, Frequency span, Resolution bandwidth, Video bandwidth.

3) Amplitude axis setting values display

Reference level, Input attenuator, Display scale.

4) Sweep axis setting values display

Sweep time, Detection mode.

5) Calculation function display**6) Measuring function display****7) Operating information display****8) Loaded trace information display**

This is also used as a setting values display when the measuring function is used.

9) Display for function keys**10) Measured values display**

Function Key Menu

5. Function Key Menu

5.1 List of the Function key menus

The types of function keys are shown in the table below. For description of each function, see the detailed pages. For the flow of change in the function key display, refer to „5.2 Menu tree“.

Function key menu	Key flow	Page
A) Adj Ch OFS	MEAS→(F6)→(F2)→F2	21
Adj Ch Pw	MEAS→(F6)→F2	21
Adj Ch WIDTH	MEAS→(F6)→(F2)→F3	21
ANT	MEAS→(F6)→(F5)→F1	22
AVER	CALC→F4	19
B) B.L.	DSPL→F2	26
BACK SPACE	FREQ→F5→F6	15
BAND CNTR	MEAS→(F6)→(F1)→(F1)→F2	21
BAND WIDTH	MEAS→(F6)→(F1)→(F1)→F3	21
BAUD	RS232C→F2	26
BLCTR	DSPL→F3	26
BUZZR	DSPL→F5	26
C) CENTER FREQ	FREQ→F1	15
CENTER FREQ	FREQ→F2	15
Ch Power	MEAS→(F6)→F1	20
CLEAR	FREQ→F5→F5	15
CONV	MKR→F6	19
CTRS	DSPL→F1	26
D) DET	SWEEP→F4	18
E) E/F ANT	MEAS→(F6)→(F3)→F4	22
EncST	FREQ→F4	15
EXEC	RS232C→F3	26
EXECUTE DEL	SAVE/LOAD→F5	20
EXECUTE LOAD	SAVE/LOAD→F4	20
EXECUTE SAVE	SAVE/LOAD→F3	20
F) Freq COUNT	MEAS→F6	20
I) IMP	REFER→F6	17
INVT	DSPL→F4	26
K) KEYST	FREQ→F3	15
M) M/F PROBE	MEAS→(F6)→F5	25
MAXHD	CALC→F2	18
MEAS OFF	MEAS→(F1 to 5)→F6	25
MINHD	CALC→F3	19
MKR DELTA	MKR→F2	19
MKR NORM	MKR→F1	19
MODE	MEAS→(F6)→(F1 to 3)→F1	21/22
N) NORM	CALC→F1	18
NUM	FREQ→F5	15
O) Occ BW	MEAS→(F6)→F3	22
OFSdB	REFER→F5	16
OVRWR	CALC→F5	19

P) PARAM	SAVE/LOAD→F2	20
PEAK SEARCH CNTR	MKR→(F3)→F4	19
PEAK SEARCH NEXT	MKR→(F3)→F5	19
PEAK SEARCH NORM	MKR→(F3)→F3	19
PEAK SEARCH PEAK	MKR→(F3)→F4	19
PEAK SEARCH WIDTH	MKR→(F3)→F5	19
PEAK SEARCH ZONE	MKR→(F3)→F3	19
PRE SET	SAVE/LOAD→F6	20
PROBE	MEAS→(F6)→(F5)→F1	25
R) RATIO	MEAS→(F6)→(F3)→F2	22
RBW ALL	RBW→F3	17
RBW AUTO	RBW→F2	17
RBW MANU	RBW→F1	17
REFERENCE CNTR	MEAS→(F6)→(F2)→F4	21
REFERENCE WIDTH	MEAS→(F6)→(F2)→F5	21
S) SCALE 10dB	SCALE→F1	17
SCALE 2dB	SCALE→F2	17
SET MKR	FREQ→F6	15
SWEEP ALL	SWEEP→F3	18
SWEEP AUTO	SWEEP→F2	18
SWEEP MANU	SWEEP→F1	18
T) TRACE	SAVE/LOAD→F1	19
	RS232C→F1	26
U) UNIT	REFER→F1 to 4	16
V) VBW ALL	VBW→F3	18
VBW AUTO	VBW→F2	17
VBW MANU	VBW→F1	17

5.2 Menu tree

The displayed items on the bottom of the screen correspond to the function keys under them, as shown in the figure below:

„Displayed items on the bottom of the screen“

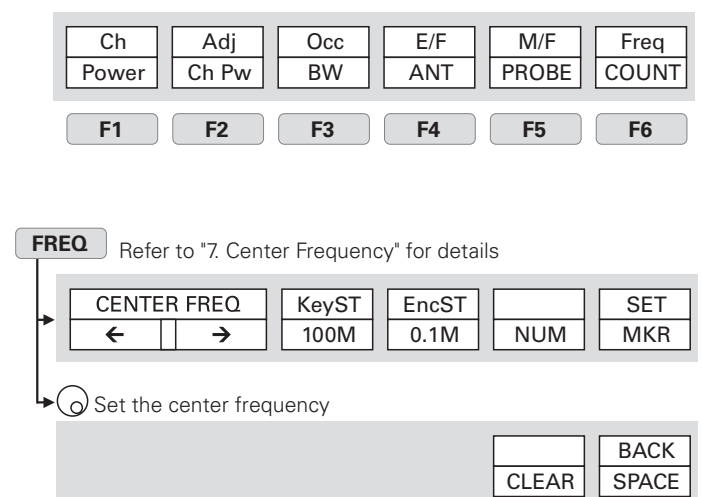

REFER Refer to "9. Reference Level" for details

UNIT				OFSdB	IMP
dBm	dB μ V	dBmV	dBV	0.0	50 Ω

Set the reference level

CALC Refer to "16. Calculation functions" for details

NORM	MAXHD	MINHD	AVER	OVRWR
	**	**	256	

Set the number

RBW Refer to "11. Resolution Bandwidth" for details

RBW		
MANU	AUTO	ALL

Set the RBW

SCALE Refer to "10. Display Scale" for details

SCALE	
10 dB	2 dB

Set the display scale

VBW Refer to "12. Video Bandwidth" for details

VBW		
MANU	AUTO	ALL

Set the VBW

SWEEP Refer to "13. Sweep Axis" for details

SWEEP		
MANU	AUTO	ALL

Set the sweep time

MEAS 1st Refer to "19. Measuring Function" for details

Ch	Adj	Occ	E/F	M/F	Freq
Power	Ch Pw	BW	ANT	PROBE	COUNT

Set the parameter

MODE	BAND		MEAS
BAND	CNTR	WIDTH	OFF

Set the parameter

MODE	Adj Ch Pw	REFERENCE	MEAS
TOTAL	OFS WIDTH	CNTR WIDTH	OFF

Set the parameter

MODE	RATIO	MEAS
N%	99.5%	OFF

ANT	MEAS
M301	OFF

MEAS 2nd

Ch	Adj	Occ	E/F	M/F	Freq
Power	Ch Pw	BW	ANT	PROBE	COUNT

Input the probe ID (first time only) –
Refer to "19.5 Magnetic field strength measurement" for details

PROBE	MEAS
CP-2S	OFF

MKR Refer to "17. Marker / Peak Search" for details

MKR		PEAK SEARCH			CONV
NORM	DELTA	NORM	PEAK	NEXT	dBm→W

Move the marker position (NORM mode) ↑ F3: Changing the marker mode

MKR		PEAK SEARCH			CONV
NORM	DELTA	ZONE	CNTR	WIDTH	dBm→W

Set the zone center frequency (ZONE mode)

SAVE/LOAD Refer to "18. SAVE/LOAD" for details

TRACE	PARAM	EXECUTE			PRE
00	00	SAVE	LOAD	DEL	SET

Set the address to store the trace

RS 232 C Refer to "22. Data Output" for details

TRACE	BAUD	
CURR	38400	EXEC

Set the trace to transfer

DSPL Refer to "20. Screen Control" for details

CTRS	B.L.	BLCTR	INVT	BUZZR
140	ON	200	OFF	ON

Set the contrast

Preparing for Operation

6. Preparing for Operation

6.1 Stand

Utilize the stand on the back to use the screen in an easier-to-see angle on the desk.

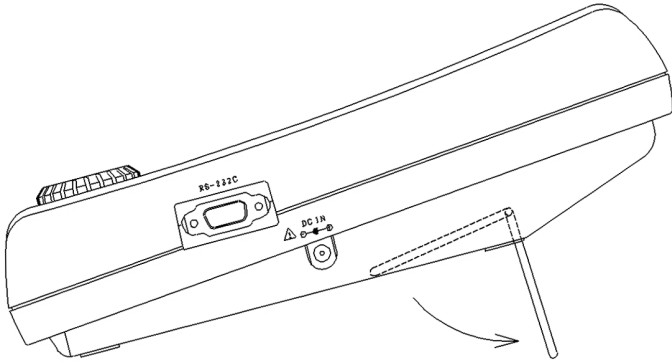

6.2 Connection to power supply

The MA300 AC adapter is both for the use with AC power supply and for charging the MB300 built-in battery (charge is started automatically if AC adapter is connected).

Connect the adapter as in the figure below and connect the AC plug to the power line (100 to 240 VAC, 50/60 Hz). For static electricity protection, ground the unit by connecting the three cores if possible. Not grounding the unit can damage it and the object measured. Do not use an AC adapter other than the MA300 supplied with the unit. Using an AC adapter other than the MA300 may cause damage to the unit.

Battery full charge time: approx. 8 hours
Battery operate time: the longest 120 min (back light OFF)
Battery full charge time with MBC300: approx. 120 to 150 min

When it is not operated at normal temperature and setting parameters is the initialization.

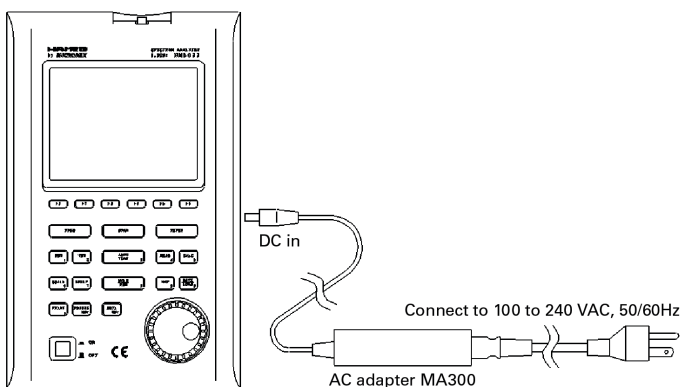

If the voltage of a battery becomes low at the time of battery operation, it will be displayed on a screen as „Low Batt“ and a buzzer will sound (it sounds, even if it is set up so that a buzzer may not sound), and a power supply will be shut off within several minutes. At that time, since the switch is the position of „ON“, please push once and return to the position of „OFF“. If it is with the position of „ON“

after a power supply is shut off, it discharges inside, will be in electric overdischarge state, and becomes the cause of contracting the life of a battery. Please take care.

Moreover, under low temperature (near 0 °C), since a battery performance falls and voltage becomes low, even when capacity remains enough, it may display on a screen as „Low Batt“.

When a battery repeats charge and electric discharge, the fall (the fall of capacity and increase in internal resistance) of a battery performance begins from about 200 times, and capacity falls to the original half by about 500 times also under good conditions. On bad conditions (high temperature, etc.), the life of battery will be shorter than this.

6.3 Replacing the fuse

5 A / 250 V fuse (IEC127-2 sheet3, slow-blow type) is used for the battery power supply. When replacing it, turn the power off first, disconnect the AC adapter, remove the battery cover and on the back as shown in the figure below, remove the battery, and then take sufficient care to perform the replacement. Be sure to use the fuse supplied with the unit, or specified one.

6.4 Installing the battery

When installing the battery, turn the power off first, disconnect the AC adapter, open the battery cover on the back of the unit after removing the two screws as shown in the figure below, and then take sufficient care to perform the installation. Be sure to use the specified battery, MB300.

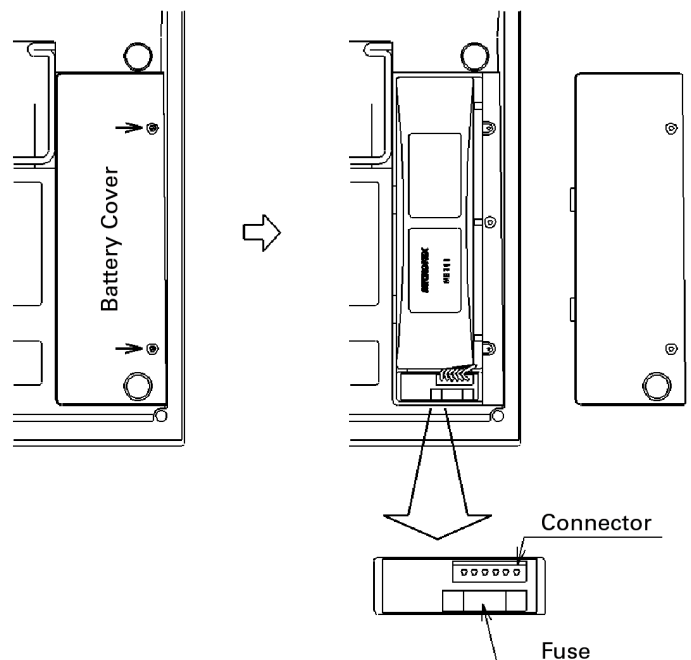

6.5 Soft carrying case

When carrying the unit or using it outdoors, the soft carrying case is convenient. You can also carry the AC adapter and printer with it, putting them in the accessory pouch.

Avoid using the unit in the soft carrying case in places where temperature is high because, with the soft carrying case, the temperature inside becomes higher than the ambient temperature.

7. Center Frequency <FREQ>

Press **FREQ** to switch over to the function screen shown below:

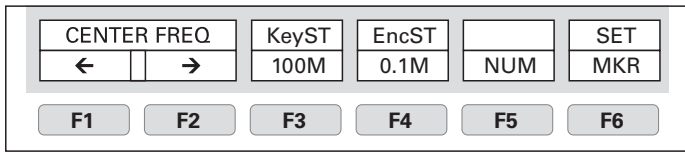

Center frequency can be set between 0 to 3.3 GHz. Center frequency may shift for the time being (1 to 10 sec.), after changing a setting.

7.1 Setting with the step keys ([F1], [F2])

- Each time **F1** is pressed, the center frequency decreases in the set step size.
- Each time **F2** is pressed, the center frequency increases in the set step size.
- Setting the step size:
Each time **F3** is pressed, it is set in the following order:



7.2 Setting with the encoder

- When is turned, the center frequency changes in the set step size.
- Setting the step size:
Each time **F4** is pressed, it is set in the following order:



7.3 Setting with the numeric keys

- Press **F5** to enter into the numeric key input mode.
[F5] functions as the <CLEAR> key. [F6] functions as the <BACK SPACE> key.
In this mode, setting with [F1], [F2] or the encoder is not accepted.
- The center frequency can be directly input according to the „Numeric Key Mapping Diagram“.
- The value is entered by pressing a unit key, [MHz (RS232C)] or [GHz (DSPL)].
Any figures below the resolution (100 kHz) will be discarded.
- Changing the setting:

F5 : Deletes the entire value and allows you to input one from the beginning.

F6 : Deletes the last input figure.

- Canceling the numeric key mode:

FREQ : Enables setting with step keys ([F1], [F2]) or the encoder again.

„Numeric Key Mapping Diagram“

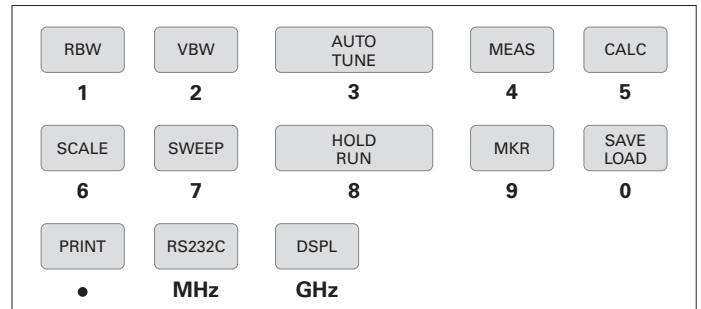

7.4 According to the Marker position

- When **F6** is pressed, the center frequency is set according to the frequency of current marker position.

Any figures below the resolution (100 kHz) will be discarded. This does not operate when the marker is not displayed (and the function display disappears).

8. Frequency Span

Press **SPAN** and use to set the frequency span.

The frequency span can be set only with the encoder. Function keys are not available.

- When is turned, the frequency span changes in the specified step.

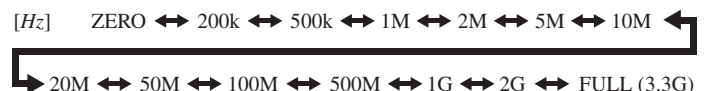

Reference Level

9. Reference Level <REFER>

Press **REFER**

to switch over to the function screen shown below:

UNIT				OFSdB	IMP
dBm	dBμV	dBmV	dBV	0.0	50 Ω
F1	F2	F3	F4	F5	F6

9.1 Setting the Reference level

- When  is turned, the reference level changes. (Refer to „9.3 Reference level setting range for each unit“ for details.)

9.2 Switching units of amplitude axis

(dBμV/m and dBμA/m are optional. Refer to „19.4 Electric field strength measurement“ and „19.5 Magnetic field strength measurement“ for details.)

- Press **F1** to switching units to dBm.

Press **F2** to switching units to dBμV

Press **F3** to switching units to dBmV

Press **F4** to switching units to dBV

9.3 Reference level setting range for each unit

UNIT	dBm	dBμV	dBmV	dBV
MAXIMUM	10	117	57	-3
MINIMUM	-40	67	7	-53
MINIMUM*	-60	47	-13	-33

(*shifted trace data)

„Unit that is able to use it with the measuring function“

UNIT	dBμV/m**					dBμA/m***
	M301	M302	M303	M304	M305	
Setting						CP2S
MAXIMUM	143	146	148	150	137	160 to 203
MINIMUM	93	96	98	100	87	110 to 153
MINIMUM*	73	76	78	80	67	90 to 133

(*shifted trace data)

(* Electric field strength measurement)

(*** Magnetic field strength measurement)

When the reference level is set between the „MINIMUM“ and „MINIMUM (shifted trace data)“, the trace in „MINIMUM“ is shifted and displayed on a screen. When the reference level is set below to the „MINIMUM“, the ATT display area is displayed as „SNV AMP“:

Calculation expression (conversion formula to and from dBm):

$$\mathbf{A} \text{ [dB}\mu\mathbf{V]} = 107 + X \text{ [dBm]}$$

$$\mathbf{B} \text{ [dBmV]} = 47 + X \text{ [dBm]}$$

$$\mathbf{C} \text{ [dBV]} = -13 + X \text{ [dBm]}$$

$$\mathbf{D} \text{ [dB}\mu\mathbf{V/m]} = 68.8/\lambda \times \sqrt{X/\text{Gar}} \text{ [dBm]}$$

λ : Wavelength[m]

Gar: Antenna absolute gain [times]

$$\mathbf{E} \text{ [dB}\mu\mathbf{A/m]} = 180 + X + F \text{ [dBm]}$$

F: probe calibration coefficient
changes by frequency

9.4 Relation between the reference level and ATT · AMP (in dBm indication)

The programmable attenuator (ATT) and the input amplifier (AMP) inside HM5033 are automatically set according to the setting value of the reference level (REFER). ATT cannot be set independently.

REFER (dBm)	ATT (dB)	AMP (dB)	REFER (dBm)	ATT (dB)	AMP (dB)
10	25	0	-16	20	21
9	24	0	-17	19	21
8	23	0	-18	18	21
7	22	0	-19	17	21
6	21	0	-20	16	21
5	20	0	-21	15	21
4	19	0	-22	14	21
3	18	0	-23	13	21
2	17	0	-24	12	21
1	16	0	-25	11	21
0	15	0	-26	10	21
-1	14	0	-27	9	21
-2	13	0	-28	8	21
-3	12	0	-29	7	21
-4	11	0	-30	6	21
-5	10	0	-31	5	21
-6	9	0	-32	4	21
-7	8	0	-33	3	21
-8	7	0	-34	2	21
-9	6	0	-35	1	21
-10	5	0	-36	5	26
-11	4	0	-37	4	26
-12	3	0	-38	3	26
-13	2	0	-39	2	26
-14	1	0	-40	1	26
-15	0	0			

When the input signal level is higher than the suitable level for 1st mixer's terminal, it generates harmonics distortion and spurious. HM5033 is designed so the input signal level of 1st mixer is determined between -20 and -25 dBm by the reference level. An input level to 1st mixer is calculated for by the following formula.

$$\mathbf{Input \ level \ of \ 1st \ mixer \ [dBm]} = \text{Input level [dBm]} - (\text{Fixed ATT} + \text{Insertion loss [dB]}) - \text{ATT [dB]} + \text{Input AMP [dB]}$$

„(Fixed ATT + Insertion loss [dB])“ is always 5 dB.

9.5 Setting the offset level

- Press **F5** and use  to set the offset of reference level. When amplifier and attenuator are used externally, display level can be matched by offset. The setting range is from -50.0 to 50.0 dB (0.1 dB step). Offset is calculated to the reference level, and it is displayed.

When offset is set, it is displayed on LEVEL display area as „OFS“:

Furthermore, the value of a marker point is displayed reflecting the calculated offset.

Offset of dBμV, dBmV, dBV, W, etc. are changed automatically.

9.6 Setting the input impedance

1. Press **F6** and use \odot to select the input impedance compensation.

50Ω ↔ 75Ω

When coaxial adaptor MA301 (50 Ω/75 Ω impedance converter) is attached, and choose „75 Ω“, then offset is calculated to the reference level, and it changes for the measured value as 75 Ω system, and display it.

When „75 Ω“ is selected, „75 Ω“ is displayed in the LEVEL area on the screen. When „75 Ω“ is selected, the offset is set to 5.7 dB (insertion loss of MA301). Moreover, can set offset. Moreover, while setting the unit of the marker point to [W, V, V/m] etc, it changes from dBm correctly.

When you set it as „75 Ω“, please be sure to attach coaxial adapter MA301 (50 Ω/75 Ω impedance converter).

10. Display Scale <SCALE>

Press **SCALE** to switch over to the function screen shown below:

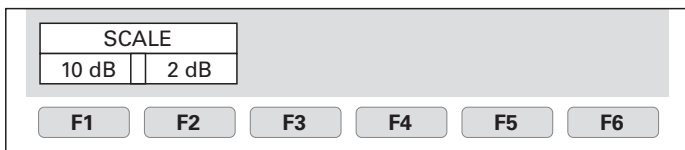

10.1 Setting with the keys ([F1], [F2])

1. Press **F1** to set the 10 dB/div display scale.
2. Press **F2** to set the 2 dB/div display scale.

10.2 Setting with the encoder

1. Turn \odot to switch between the 10 dB/div and 2 dB/div display scale.

10dB ↔ 2dB

In 2 dB/div, display level may not become smaller than fixed level, by frequency compensation.

11. Resolution Bandwidth <RBW>

Press **RBW** to switch over to the function screen shown below:

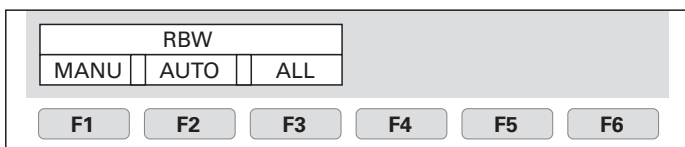

Any selected parts of MANU, AUTO and ALL become inverted display.

11.1 MANUAL mode

1. Press **F1** or turn the \odot to enter MANUAL mode.
Use \odot to set the RBW.

3kHz ↔ 10kHz ↔ 30kHz ↔ 100kHz ↔ 300kHz ↔ 1MHz ↔ 3MHz

11.2 AUTO mode

1. When **F2** is pressed, optimum RBW is set according to the settings of SPAN and SWEEP.

Since „“ is displayed on the right end of RBW setting value display portion of a screen when set as AUTO mode, it can check being set as AUTO mode.*

11.3 ALL AUTO mode

1. When **F3** is pressed, optimum RBW, VBW and SWEEP are set according to the setting of SPAN.

Since „“ will be displayed on the right end of each setting value display portion of RBW, VBW, and SWEEP if ALL AUTO mode is set up, it can check being set as ALL AUTO mode.*

When RBW is set as 3 kHz or 10 kHz, selectivity (60 dBc) becomes larger than an actual value, by influence of SSB phase noise.

12. Video Bandwidth <VBW>

Press **VBW** to switch over to the function screen shown below:

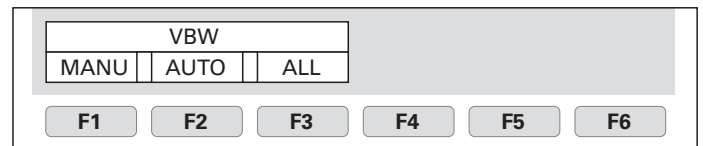

Any selected parts of MANU, AUTO and ALL become inverted display.

12.1 MANUAL mode

1. Press or turn the \odot to enter MANUAL mode.
Use \odot to set the VBW.

100Hz ↔ 300Hz ↔ 1kHz ↔ 3kHz ↔ 10kHz ↔ 30kHz ↔ 100kHz ↔ 300kHz ↔ 1MHz

12.2 AUTO mode

1. When **F2** is pressed, VBW is set according to the settings of SPAN and SWEEP.

Since „“ is displayed on the right end of VBW setting value display portion of a screen when set as AUTO mode, it can check being set as AUTO mode.*

Sweep Axis - Auto Tuning - Hold/Run - Calculation Function

12.3 ALL AUTO mode

- When **F3** is pressed, RBW, VBW and SWEEP are set according to the setting of SPAN.

Since „*“ will be displayed on the right end of each setting value display portion of RBW, VBW, and SWEEP if ALL AUTO mode is set up, it can check being set as ALL AUTO mode.

13. Sweep Axis - Detection Mode <SWEEP>

Press **SWEEP** to switch over to the function screen shown below:

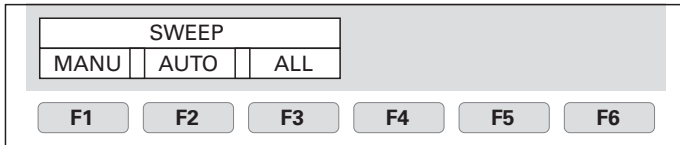

Any selected parts of MANU, AUTO and ALL become inverted display. When [F4] is pressed, the part of DET become inverted display.

13.1 MANUAL mode

- Press **F1** or turn the to enter MANUAL mode. Use to set the SWEEP.

10ms ↔ 30ms ↔ 0.1s ↔ 0.3s ↔ 1s ↔ 3s ↔ 10s ↔ 30s

Can't set 10ms at the FULLSPAN.

13.2 AUTO mode

- When **F2** is pressed, SWEEP is set according to the settings of SPAN and RBW.

Since „*“ is displayed on the right end of SWEEP setting value display portion of a screen when set as AUTO mode, it can check being set as AUTO mode.

13.3 ALL AUTO mode

- When **F3** is pressed, RBW, VBW and SWEEP are set according to the setting of SPAN.

Since „*“ will be displayed on the right end of each setting value display portion of RBW, VBW, and SWEEP if ALL AUTO mode is set up, it can check being set as ALL AUTO mode.

13.4 Setting the Detection mode

- Pressing **F4** allows you to change the method to capture the trace.



PosPK (Positive Peak): Traces the maximum value of the sample points.
SMPL (Sample): Traces the momentary value of the sample points.
NegPK (Negative Peak): Traces the minimum value of the sample points.

When sweep time is 10ms or 30ms, detection mode is set to SMPL.

14. AUTO Tuning <AUTO TUNE>

- When **AUTOTUNE** is pressed, center frequency is set at the spectrum of the maximum level in the 3.3 GHz band, and in addition, optimum reference level, RBW, VBW and SWEEP are set according to the setting of SPAN.

The AUTO tuning does not operate normally, at the time of the following 4 conditions.

- 1) ZERO SPAN
- 2) FULL SPAN
- 3) Signal level is -40 dBm or lower
- 4) Signal frequency is 50 MHz or lower

15. Hold/Run <HOLD/RUN>

- Press **HOLD/RUN** to switch to between sweep halt and continuous sweep.

This operates only with the key press, with no function indication.

16. Calculation Function <CALC>

Press **CALC** to switch over to the function screen shown below:

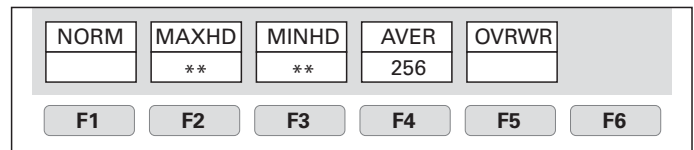

After sweeps stops, press **HOLD/RUN** to restart sweep. Press [F1] to [F5] to set the CALC mode. Use to set the number of sweeps.

16.1 NORM mode

- Press **F1** Calculation is not performed in this mode. The number of sweeps is always unlimited.

Usually, please choose this mode. „NORMAL“ is displayed in the CALC area on the LCD screen. (Refer to „4. Description of Display“ for details)

16.2 MAX HOLD mode

- Press **F2** and use to set the number of sweeps.



2. Sweeps are performed the set number of times, the maximum value of each point of trace data is displayed as a trace, and then sweep is halted.

„MAX — (number of sweeps)“ is displayed in the CALC area on the LCD screen. (Refer to „4. Description of Display“ for details)

16.3 MIN HOLD mode

1. Press **F3** and use \odot to set the number of sweeps.
2. Sweeps are performed the set number of times, the minimum value of each point of trace data is displayed as a trace, and then sweep is halted.



„MIN — (number of sweeps)“ is displayed in the CALC area on the LCD screen. (Refer to „4. Description of Display“ for details)

16.4 AVERAGE mode

1. Press **F4** Use \odot to set the number of sweeps.
2. Sweeps are performed the set number of times, average value of each point of trace data is displayed as a trace, and then sweep is halted.

2 ↔ 4 ↔ 8 ↔ 16 ↔ 32 ↔ 64 ↔ 128 ↔ 256

„AVG — (number of sweeps)“ is displayed in the CALC area on the LCD screen. (Refer to „4. Description of Display“ for details)

16.5 OVER WRITE mode

1. Press **F5** to enter into the OVER WRITE mode, where traces are written one over another. The number of sweeps is unlimited.

„OVER WR“ is displayed in the CALC area on the LCD screen. (Refer to „4. Description of Display“ for details) Only the last one trace is saved.

17. Marker - Peak Search <MKR>

Press **MKR** to switch over to the function screen shown below:

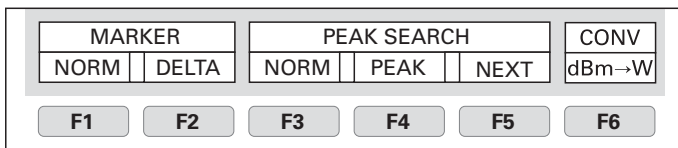

The display when an NORM marker is selected. The marker is manually moved at NORM mode. Peak search function, NEXT peak function is available.

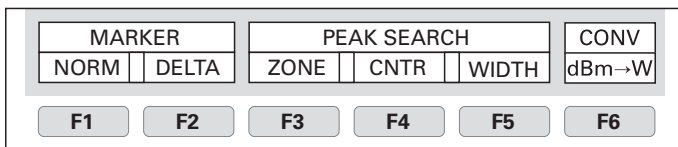

The display when an ZONE marker is selected. The marker moves to the highest peak position automatically at ZONE mode, inside specified zone.

17.1 Moving the marker

- Use **F1** and \odot to move the marker.
- Use **F2** to put DELTA REF at the current marker position.

17.2 Setting the peak search <PEAK SEARCH>

NORM mode (Use **F3** to select NORM.)

Use **F4** to move the marker to the maximum peak position.

Use **F5** to move the marker successively from higher to lower peak positions other than the maximum peak. (The marker moves to 10 peaks.)

When you move the marker to the 10th peak or moving the marker, the NEXT peak search function stops and the function display disappears.

ZONE mode (Use **F3** to select ZONE.)

Use **F4** and \odot to move the center position.

Use **F5** and \odot to change the width.

17.3 Changing the unit of marker point

Press **F6** to change the unit of marker point.

When unit of reference level is dBm, the unit is changed from [dBm] to [W].

When unit of reference level is dBμV, the unit is changed from [dBμV, dBmV, dBV] to [V].

When unit of reference level is dBμV/m, the unit is changed from [dBμV/m] to [V/m].

When unit of reference level is dBμA/m, the unit is changed from [dBμA/m] to [A/m].

Moreover, according to each unit, it is displayed as follows.

- [W] ↔ [W, mW, μW, nW, pW, fW]
- [V] ↔ [V, mV, μV, nV]
- [V/m] ↔ [V/m, mV/m, μV/m, nV/m]
- [A/m] ↔ [A/m, mA/m, μA/m, nA/m]

18. Save/Load <SAVE/LOAD>

Press **SAVE/LOAD** to switch over to the function screen shown below:

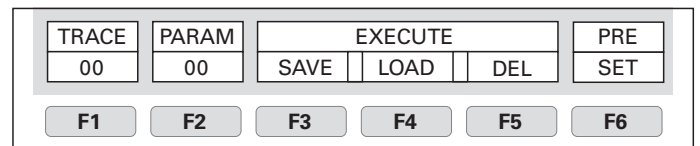

18.1 Setting the location to store the trace

1. Pressing **F1** allows you to set the number of location to store the trace.
2. Use \odot to set the number of location.

00 ↔ 01 ↔ 02 ↔ 03 ↔ 04 ↔ ... ↔ 98 ↔ 99

The part of TRACE become inverted display after it is selected.

Measuring Function

18.2 Setting the location to store the parameter

- Pressing **F2** allows you to set the number of location to store the parameter.
- Use **⊙** to set the number of location.

00 ↔ 01 ↔ 02 ↔ 03 ↔ 04 ↔ ... ↔ 98 ↔ 99

The part of PARAM become inverted display after it is selected.

18.3 Saving the data

- Press **F3** to save the data at the set number.

This saves the trace when TRACE is selected, or the setting parameters when PARAM is selected.
 „*“ is displayed on the right end of the number of location place at which data is saved.
 It can be overwritten, too.

18.4 Loading the data

- Press **F4** to read out the data at the set number.

This reads out the trace when TRACE is selected. The setting parameter of the loaded trace is displayed in the loaded trace information display area. (Refer to „4. Description of Display“ for details)

This reads out the setting parameters when PARAM is selected.

When you load a trace, the current trace disappears, the HOLD state is set, and the loaded trace is displayed. For the loaded trace, you can use the marker, but cannot use a measuring function. When you press the HOLD/RUN key, the loaded and the current traces are displayed overlapping each other.

„*“ is displayed on the right end of the number of location place at which data is saved.

When you search the trace or setting parameters to be read out, repeat **F4** ↔ **⊙** ↔ **F4** ..., and load the trace or setting parameters in turn.

18.5 Clearing the loaded trace

- Press **F5** to clear the loaded trace that has been displayed.

18.6 Presetting (Initialization)

- Press **F6** to preset the setting parameters as the Initialization shown below:

„Initialization“

Items	Parameter	Items	Parameter
Center frequency	1 GHz	Sweep time	0.3 s
Frequency span	20 MHz	Detection mode	Positive peak mode
Reference level	10 dBm	RBW	100 kHz
Offset	0.0 dB	VBW	10 kHz
Impedance	50 Ω	Display scale	10 dB/div

19. Measuring Function<MEAS>

Press **MEAS** to switch over to the function screen shown below:

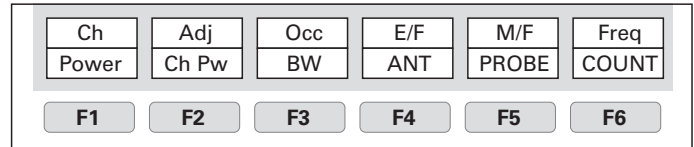

Select the measuring function:

- F1 Ch Power:** Channel power measurement
- F2 Adj Ch Pw:** Adjacent channel leakage power measurement
- F3 Occ BW:** Occupied frequency bandwidth measurement
- F4 E/F ANT:** Electric field strength measurement
- F5 M/F PROBE:** Magnetic field strength measurement (optional)
- F6 Invalid**

Once you select the measuring function, pressing **MEAS** next time will directly bring up the function screen for the function you selected the last time. If you want to stop the measuring function, or if you want to select another measuring function, press [F6] (MEAS OFF). This stops the measuring function and switches to the above screen, which allows you to select the measuring function.

The measuring function is stops, when push **MKR** while these 4 functions (Channel power, Adjacent channel leakage power, Occupied frequency bandwidth, Frequency counter) are selected. Because each 4 functions and marker operation cannot be used simultaneously. Similarly, the function of the marker stops, when the functions of these 4 measurements are selected while using the marker.

The unit displays data in 251 horizontal dots, but it internally captures the trace and calculates the measured value (Channel power measurement, Adjacent channel leakage power measurement and Occupied frequency bandwidth measurement) in 1001 dots.

19.1 Channel power measurement <Ch Power> **F1**

Measures the sum of the power in the zone specified. Two modes, TOTAL and BAND, are available.

TOTAL mode [Use **F1** (MODE) to select TOTAL.] Measure the sum of the power in the zone specified by the center frequency and frequency span (whole range of the screen).

It is shown on MEAS area of LCD as „CP TOTAL“
 The measured value is displayed at the right lower corner on the screen.

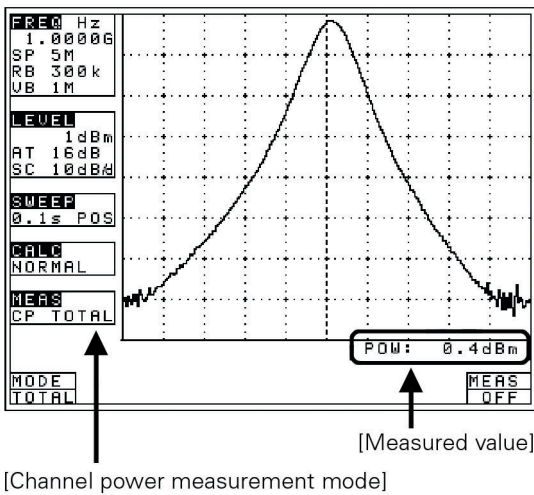

[Channel power measurement mode]

BAND mode [Use **F1** (MODE) to select BAND.]

Measure the sum of the power in the zone specified by the zone center frequency and zone width.

It is shown on MEAS area of LCD as „CP BAND“.
The measured value and setting parameter are displayed at the right lower corner on the screen.

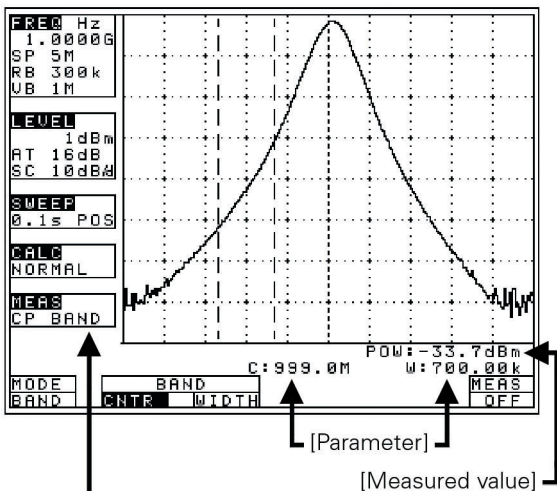

[Channel power measurement mode]

1. Use **F2** (CNTR) and \odot to set the zone center frequency.
2. Use **F3** (WIDTH) and \odot to set the zone width.

19.2 Adjacent channel leakage power measurement <Adj Ch Pw> **F2**

Measures the adjacent channel leakage power as the ratio of the power in the range specified by the offset frequency (reference carrier frequency) and the bandwidth, to the carrier wave power.

Two channels of adjacent waves on the upper and lower sides of the same offset frequency are measured. In addition, you can select from three modes, TOTAL (total power method), REF BAND (in-band method) and PEAK (reference level method), according to the classification of definitions of carrier wave.

Mode selection and measurement

[Use **F1** (MODE) to select a mode: TOTAL, BAND or PEAK.]

It is each shown on MEAS area of LCD as „ACP TOT“, „ACP BAND“ or „ACP PK“.

The measured value and setting parameter are displayed at the right lower corner on the screen.

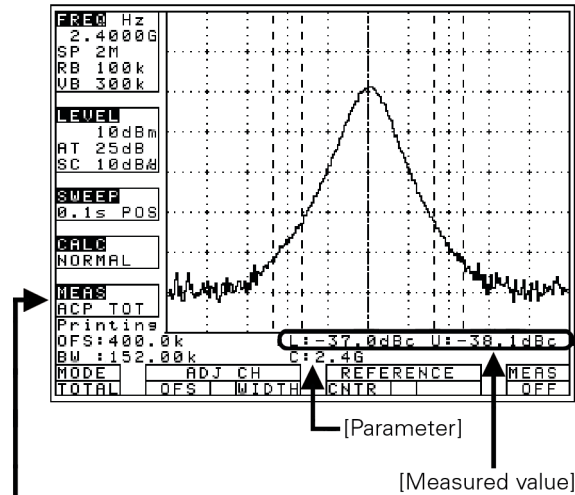

[Adjacent channel Leakage power measurement mode]

1. Use **F2** (Adj Ch OFS) and \odot to set the offset frequency of adjacent channel.

The offset is from the center frequency of the reference carrier wave.

2. Use **F3** (Adj Ch WIDTH) and \odot to set the band width of adjacent channel.

3. Use **F4** (REFERENCE CNTR) and \odot to set the center frequency of reference carrier.

[F4] is only for the TOTAL and BAND mode.

4. Use **F5** (REFERENCE WIDTH) and \odot to set the band width of reference carrier.

[F5] is only for the BAND mode.

Definition of the reference carrier for each mode

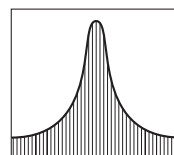

TOTAL (total power method)

This is based on the sum total of the power of whole range on the screen. Use [F4] to set center frequency of the reference carrier wave.

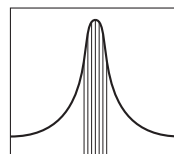

BAND (in-band method)

This is based on the sum total of the power within the set bandwidth. Use [F4] to set center frequency of the reference carrier wave.

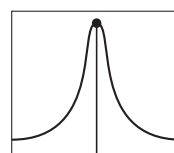

PEAK (reference level method)

This is based on the power of the peak on the screen. Center frequency of the reference carrier wave is set up to the peak inside the screen automatically.

Measuring Function

19.3 Occupied frequency bandwidth measurement <Occ BW> **F3**

Measures the bandwidth at the point of N [%] of total power (N% POWER) or the bandwidth at the point X [dB] down from the peak level (XdB DOWN). Two modes are available.

N% POWER mode [Use **F1** (MODE) to select N%.] Measures the bandwidth at the point of N [%] of total power displayed on the screen.

It is shown on MEAS area of LCD as „OBW N%“
The measured value is displayed at the right lower corner on the screen.

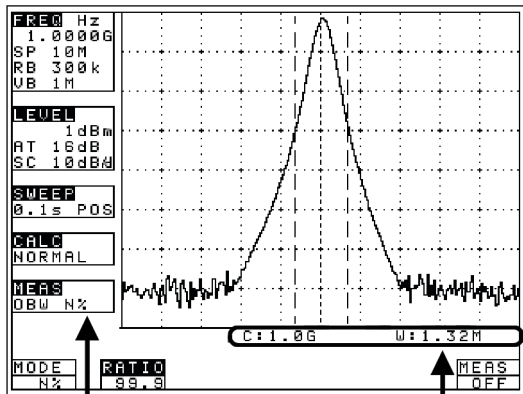

[Parameter] [Measured value]
[Occupied frequency bandwidth measurement mode]

1. Use **F2** (RATIO) and \odot to set the percentage to total power.

Setting range: 80.0 to 99.9 %.

XdB DOWN mode [Use **F1** (MODE) to select XdB.] Measures the bandwidth at the point X [dB] down from the peak level.

It is shown on MEAS area of LCD as „OBW XdB“
The measured value is displayed at the right lower corner on the screen.

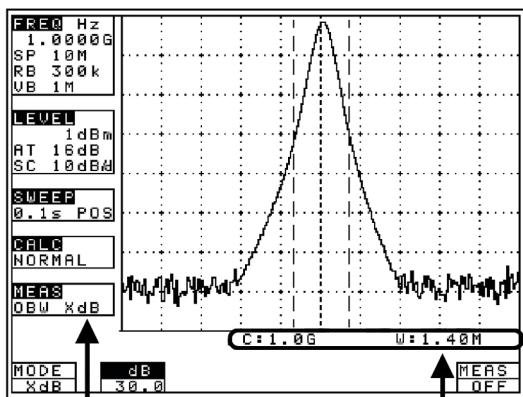

[Parameter] [Measured value]
[Occupied frequency bandwidth measurement mode]

1. Use **F2** (dB) and \odot to set the down level from peak level.

Setting range: 0.1 to 80.0 dB.

19.4 Electric field strength measurement <E/F ANT> **F4**

Measures electric field strength by connecting an optional antenna. Allows using an antenna other than options by creating and inputting the original compensation table (Refer to „23.6 Writing of original compensation data“ for how to create and write).

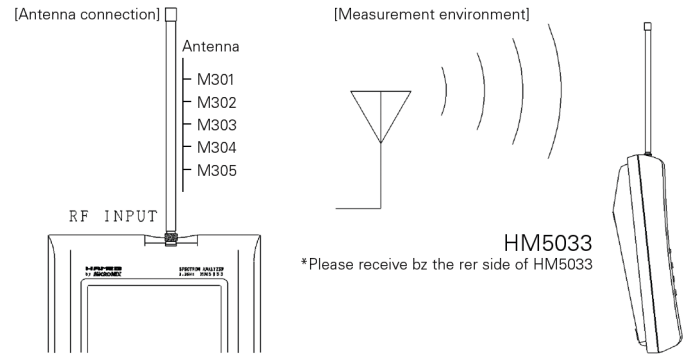

„Specifications of the antenna (antenna gain and VSWR are specified at a center of frequency range.“

Items	M301	M302	M303
Type	Sleeve	Sleeve	Sleeve
Frequency range	0.8 to 1.0 GHz	1.25 to 1.65 GHz	1.7 to 2.20 GHz
Antenna gain	+1 dBi or higher	+1 dBi or higher	+1 dBi or higher
VSWR	1.5 or lower	1.5 or lower	1.5 or lower
Dimensions	7.5 \varnothing ×250 mm	7.5 \varnothing ×250 mm	7.5 \varnothing ×180 mm
Weight	approx.20 g	approx.20 g	approx. 20 g
Reference level setting range	93 to 143 dB μ V/m	96 to 146 dB μ V/m	98 to 148 dB μ V/m

(except for the minimum value in screen shift)

Items	M304	M305
Type	Sleeve	1/4 λ whip
Frequency range	2.25 to 2.65 GHz	300 to 500 MHz
Antenna gain	+1 dBi or higher	+1 dBi or higher
VSWR	1.5 or lower	1.5 or lower
Dimensions	7.5 \varnothing ×180 mm	8.0 \varnothing ×195 mm
Weight	approx. 20g	approx.30 g
Reference level setting range	100 to 150 dB μ V/m	87 to 137 dB μ V/m

(except for the minimum value in screen shift)

Measured value varies depending on how to have HM5033 main unit. Moreover, if the person who has is different, measured value will vary. Because M305 is 1/4 λ whip antenna. Therefore, in the measurement used an antenna M305, measurement errors occurs. The error value is several dB or 10 dB or more. In order to lessen the error value, use it, separating from the body as much as possible so that there is no influence of human body.

Mode selection and measurement

Use **F1** (ANT) to select an antenna, M301, M302, M303, M304, M305 or USER. As soon as the antenna is entered, the measurement is taken.

It is each shown on MEAS area of LCD as „M/F M301“; „M/F M302“; „M/F M303“; „M/F M304“; „E/F M305“ or „M/F USER“ (Refer to „23.1 Command description“ for details.)

USER“ is an original compensation table the user creates. Trace may exceed from a screen by antenna gain compensation.

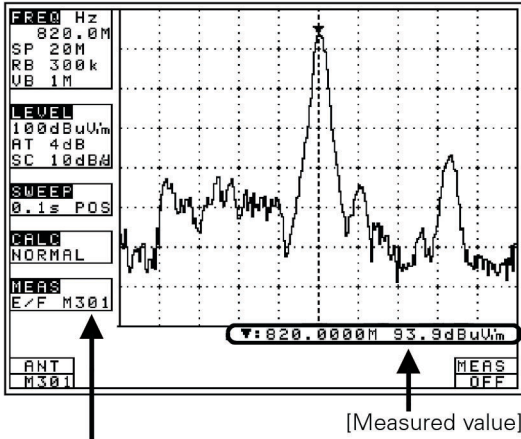

[Electric field strength measurement mode]

Unit of amplitude axis changes to [dBμV/m]

Optimum center frequency and frequency span are set according to the antenna. In addition, a trace is not displayed for frequencies outside those supported by the antenna.

Example (case of M301)

Center frequency: 900 MHz
Frequency span: 200 MHz

Antenna directivity (reference data)

E plane: X-Y axis (X direction= 0°)

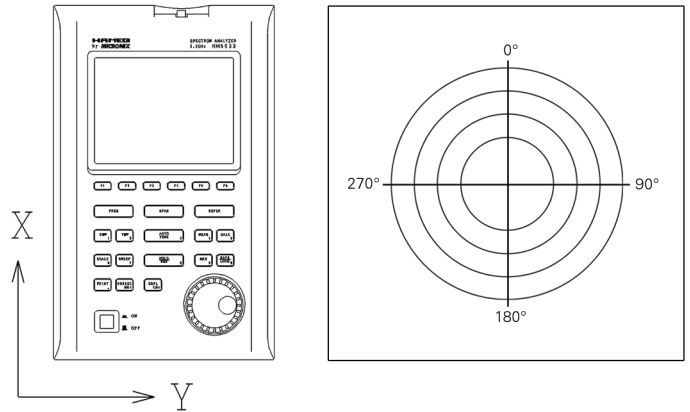

All the data are those when the antenna is connected to the RF input with no obstacles around.

However, data of M305 is reference data of the conditions in which people have HM5033 attached M305. So, the directivity changes in practice, because, for example, the unit is carried by people.

Antenna diagrams

M301 (900 MHz, E plane)

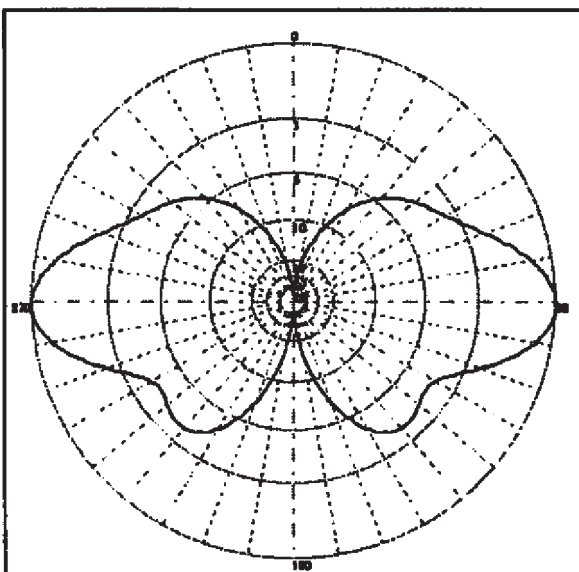

Antenna gain vs Frequency

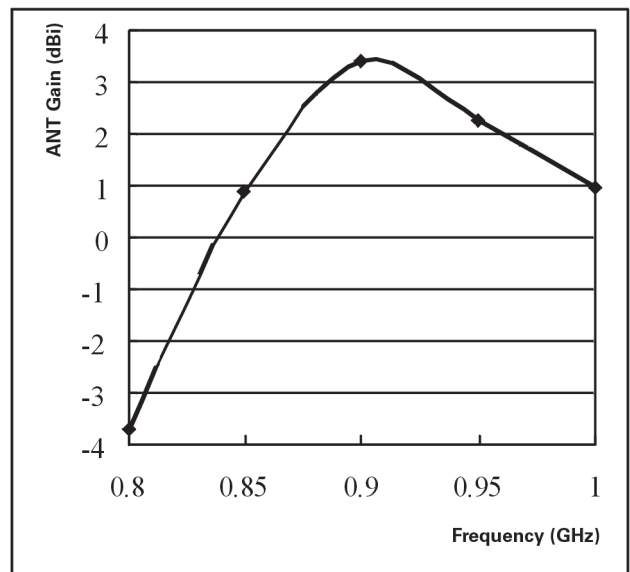

Measuring Function

M302 (1.5 GHz, E plane)

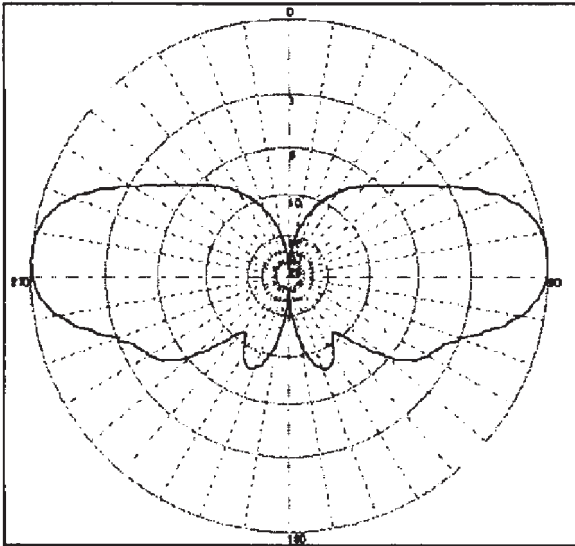

Antenna gain vs Frequency

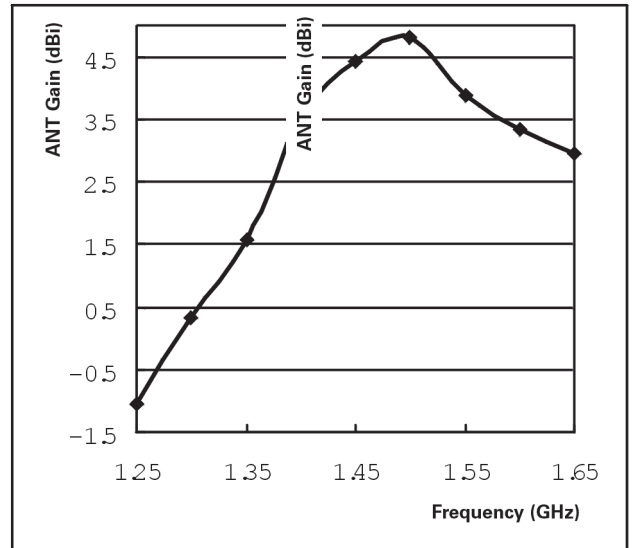

M303 (2.0 GHz, E plane)

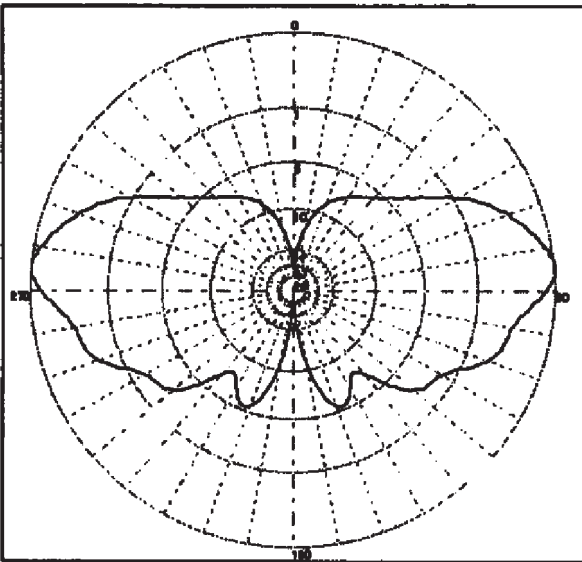

Antenna gain vs Frequency

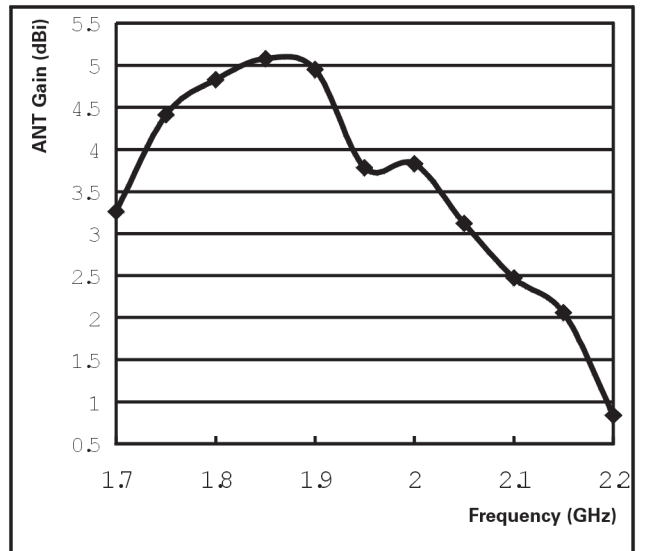

M304 (2.4 GHz, E plane)

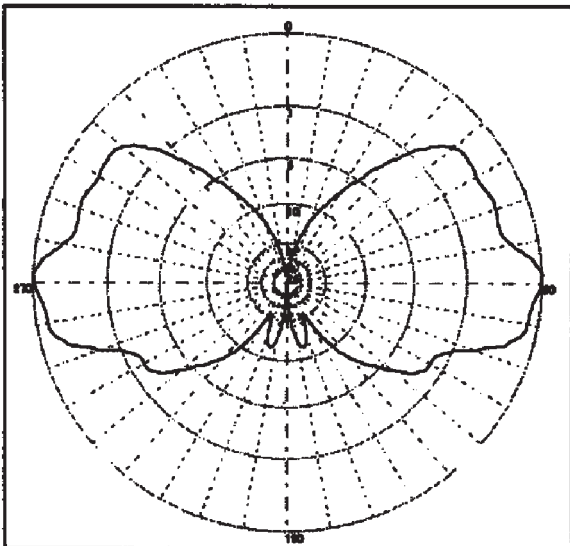

Antenna gain vs Frequency

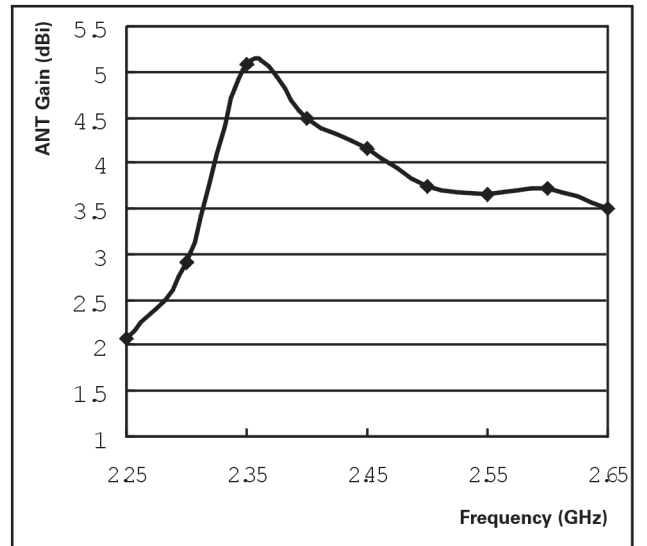

M305 (horizontal plane)

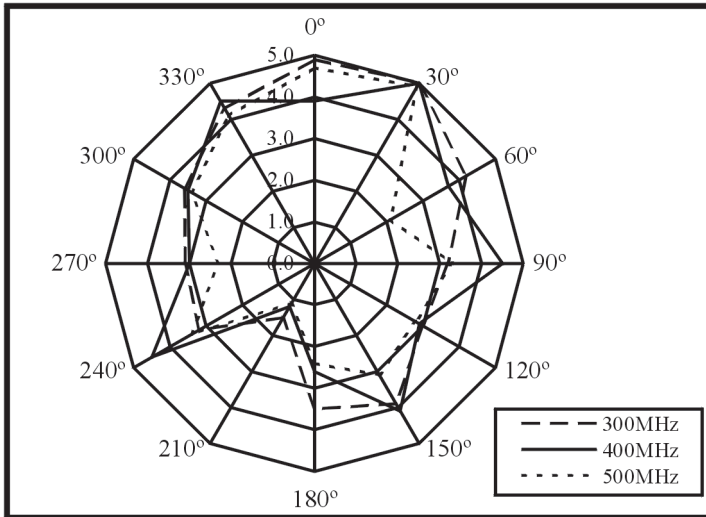

Antenna gain vs Frequency

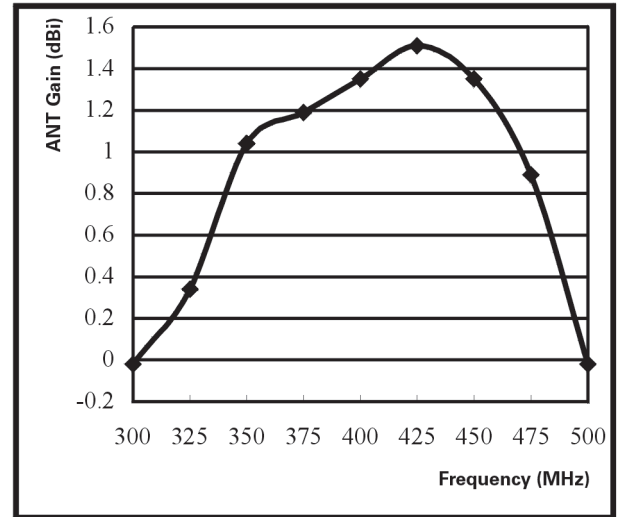

19.5 Magnetic field strength measurement <M/F PROBE> (optional) F6

Measures the magnetic field strength using the optional magnetic field probe CP-2S.

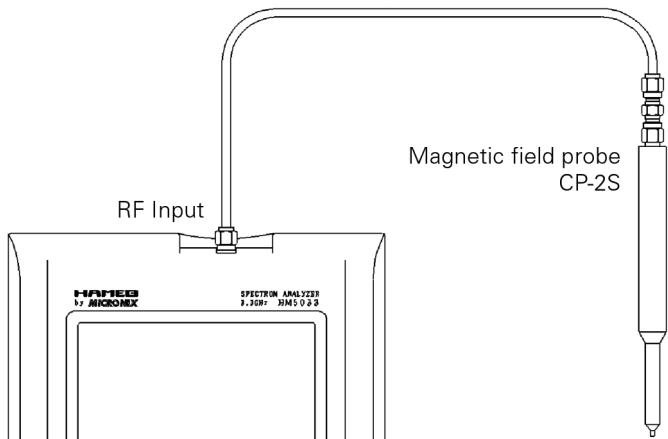

„Specifications of magnetic field probe CP-2S“

Items	Specifications
Frequency range	10 MHz to 3 GHz
Space resolution (-6dB) (Depending on objects)	approx. 0.25 mm
Dimensions	Outside: 12 mm Ø × 135mm probe tip: 2 mm (W) × 1mm (T)
Connector	SMA (P)
Reference level setting range (maximum)	160 to 203 dBμA/m
Reference level setting range (except for the minimum value in screen shift)	110 to 153 dBμA/m
Measurement error	approx. ± 1 dB (Probe simple substance)

(Refer to the operating manual for CP-2S for details)

The tip of the optional magnetic field probe CP-2S is made of glass-ceramic board. Take care when handling the probe even though the strength of the glass-ceramic board is sufficiently ensured under normal operation.

Subject to change without notice

Registration of the probe ID

Magnetic field strength measurement cannot be used without entering the „Probe ID“ attached to the optional magnetic field probe, CP-2S. Once you have entered it, you don't need to enter it again.

When you press MEAS and F6 in that order, „Input PROBE ID“ will appear in the measured value display area on the screen. Then, input the 14-digit „Probe ID“ with the numeric keypads.

Press F4 (ENTER) to confirm it.

Press F5 (CLEAR) to delete the entire value and allow you to input one from the beginning.

Press F6 (BACK SPACE) to delete the last input figure.

Press F3 to cancel the probe ID input display.

Mode selection and measurement

Use F1 (PROBE) to select a probe, CP-2S or USER. As soon as the probe is entered, the measurement is taken.

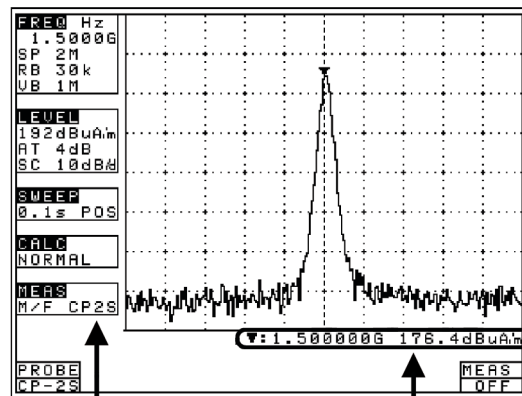

[Measuring mode]

[Measured value]

It is each shown on MEAS area of LCD as „M/F CP2S“ or „M/F USER“. „USER“ is an original calibration table the user creates. (Refer to „23.1 Command description“ for details)

Unit of amplitude axis are changing to [dBμA/m]

A trace is not displayed for frequencies outside those supported by the probe.

20. Screen Control <DSPL>

Press **DSPL** to switch over to the function screen shown below:

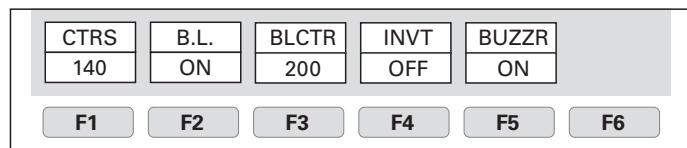

20.1 Adjusting the contrast

Use **F1** and \odot to adjust the contrast.

20.2 Switching ON and OFF the LCD backlight

Each time **F2** is pressed, the LCD backlight is alternately switched to ON or OFF.

20.3 Adjusting the brightness of the LCD backlight

Use **F3** and \odot to set the brightness.

20.4 Inverting the display

Press **F4** to invert the screen display. Press **F4** again to return it to the previous state.

20.5 Enabling or disabling the beep

Pressing **F6** allows you to disable the beep that sounds when you operate a key or the encoder. Press **F6** again to return it to the previous state.

If the voltage of a battery becomes low at the time of battery operation, it will be displayed on a screen as „Low Batt“; and a buzzer will sound (it sounds, even if it is set up so that a buzzer may not sound), and a power supply will be shut off within several minutes.

21. Printing <PRINT> (option)

When using the optional printer, connect the RS-232C cable MI180 (optional) as shown in the figure below.

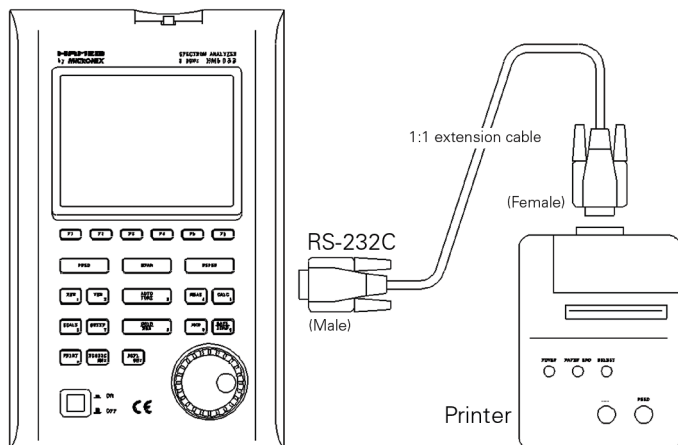

21.1 Hard copy of the screen

When you press the **PRINT** with the printer (optional) connected to the unit, it is set to the HOLD state and starts printing. It remains in the HOLD state after the printing is finished. It stops printing if you press the **PRINT** again during printing.

Since the printer operates with power supply from either the AC adapter or dry batteries, you can easily produce a hard copy of measured data even when outdoors where no AC power supply is available. When battery-powered, the printer operates for approximately 30 minutes (continuous use), allowing you to produce about 80 hard copies of the screen image.

22. Data Output <RS-232C>

Press **RS 232 C** to switch over to the function screen shown below:

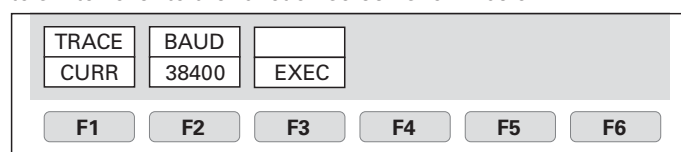

Refer to „23. RS-232C“ for „How to connect“ and „RS-232C specifications“. The trace currently displayed on the screen is transmitted when „CURR“ is selected.

22.1 Selecting the trace to transfer

Use **F1** and \odot to select a trace.

CURR \leftrightarrow 00 \leftrightarrow 01 \leftrightarrow 02 \leftrightarrow 03 \leftrightarrow ... \leftrightarrow 98 \leftrightarrow 99

An asterisk () appears when there is a saved trace at the selected number as well as „SAVE/LOAD“.*

22.2 Selecting the communication speed (baud rate)

Use **F2** and \odot to select a baud rate.

2400 \leftrightarrow 4800 \leftrightarrow 9600 \leftrightarrow 19200 \leftrightarrow 38400

22.3 Transfer the data

Press **F3** to start the transfer. The data are transmitted as ASCII cord character strings.

Contents of data

- Center frequency
CF ** [**=0.0M, 0.1M to 999.9M (0.1 step), 0.0001G to 3.3G (0.0001 step)]
- Frequency span
SP ** [**=ZERO, 200k, 500k, 1M, 2M, 5M, 10M, 20M, 50M, 100M, 200M, 500M, 1G, 2G, FULL]
- Reference level
RF ** [**=-60 to 10dBm, 47 to 117dB μ V, -13 to 57dBmV, -33 to -3dBV, 72 to 149dB μ V/m, 89 to 203dB μ A/m (all 1 step)]

4) Sweep time and Detection mode
 ST ** ## [**=10ms, 30ms, 0.1s, 0.3s, 1s, 3s, 10s, 30s]
 [##=POS, NEG, SMP]

6) Video bandwidth
 VB ** [**=100, 300, 1k, 3k, 10k, 30k, 100k, 300k, 1M]

5) Resolution bandwidth
 RB ** [**=3k, 10k, 30k, 100k, 300k, 1M, 3M]

"CR(0D[HEX])+LF(0A[HEX])" is added to the tail of every data.

Character strings	Description		Example
PARAM	This means that the data from the next line are „setting parameters“		RARAM
CF **	Center frequency	Refer to 1)	CF 2.5140G
SP **	Frequency span	Refer to 2)	SP 20M
RF **	Reference level	Refer to 3)	RF 10 dBm
ST ** ##	Sweep time and detection mode	Refer to 4)	ST 30 ms SMP
RB **	Resolution bandwidth	Refer to 5)	RB 300k
VB **	Video bandwidth	Refer to 6)	VB 1M
SC **	Display scale	(** = 10 dB/div or 2 dB/div)	SC 10 dB/div
TRACE	This means that the data from the next line are „trace data“		TRACE
** , ** , ...	These are trace data. Ten two-digit hexadecimal characters separated by commas make a line, and there are 26 lines (251 data) of data in total.		24, 20, 1f, 1f, 1e,
	For Trace 1001 data transfer, there are 101 lines (1001 data) of data in total.		23

RS-232C Interface

23. RS-232C Interface

23.1 RS-232C specifications

Transfer rate: 2400 / 4800 / 9600 / 19200 / 38400 bps
Date bit length: 8 bit
Stop bit: 1 bit
Parity check: none

23.2 How to connect

When using the RS-232C interface, connect a 1:1 Sub-D extension cable as shown in the figure below.

Cable length: approx. 1.5m
Connector: D-sub 9 pin male / D-sub 9 pin female
Wiring: straight

Refer to „22. Data Output“ about changing baud rate.
COM PORT (D-sub 9pin, male)

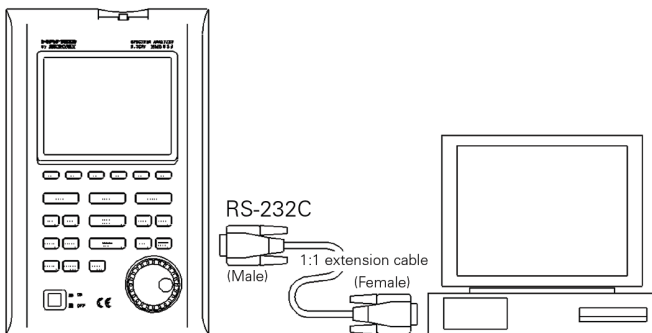

Use the conversion connector, in the case that is D-sub 25pin (male)

23.3 Command description

„CR(0D[HEX])+ LF(0A[HEX])“ is added to the tail of every command. When you send a command from your PC, HM5033 returns a response. Responses include „OK“ + CR + LF, „ERR“ + CR + LF and „(response to command)“ + CR + LF.

By inputting „?“ instead of „***“ for each command, the current setting parameters are returned. Except for „...Request“ command and command for inputting corrected data.

1) Set the center frequency

Command: `FREQ*****`
(* = 0 to 9)
(***** = Refer to [23.4 Input the frequency])

2) Request the set marker

Command: `FREQSETMKR`

The center frequency is set according to the frequency of current marker position.

3) Set the span

Command: `SPAN****`
(* = 0 to 9)
(**** = ZERO, 200K, 500K, 1M, 2M, 5M, 10M, 20M, 50M, 100M, 500M, 1G, 2G, FULL [unit: Hz])

4) Set the reference level

Command: `REF***`
(*** = -60 to 10 [1step, unit: dBm])

For units other than dBm, use the conversion formulas in „9.3 Reference level setting range for each unit“ to convert them into dBm before inputting the value.

5) Set the reference unit

Command: `UNIT****`
(**** = DBM, DBUV, DBMV, DBV)

Command	Unit
DBM	dBm
DBUV	dB μ V
DBMV	dBmV
DBV	dBV

6) Set the RBW

Command: `RBW****`
(**** = 3K, 10K, 30K, 100K, 300K, 1M, 3M, AUTO, ALL [unit: Hz])

7) Set the VBW

Command: `VBW****`
(**** = 100, 1K, 3K, 10K, 30K, 100K, 300K, 1M, AUTO, ALL [unit: Hz])

8) Start/Stop the measuring function

Command: `MEAS***`
(*** = CP, ACP, OBW, EF, MF, OFF)

Command	Measuring function
CP	Channel power measurement
ACP	Adjacent channel leakage power measurement
OBW	Occupied frequency bandwidth measurement
EF	Electric field strength measurement
MF	Magnetic field strength measurement
OFF	OFF

9) Request the result of measuring function

Command: `MEASRES`

Example of the return data

Case of channel power measurement...
POW: -25.5dBm

Case of adjacent channel power measurement...
L: -44.7dBc
U: -48.3dBc

Case of occupied bandwidth measurement...
C: 1.45G
W: 20.00k

Case of frequency counter...
FC: 2400.0000M

When the level of spectrum is small and cannot measure, it is returned as „Non signal!“

If frequency counter (factory option) is not mounting, it is returned as „Invalid for F/C“

10) Set the mode of channel power measurement

Command: CPMODE*****
 (*****= TOTAL, BAND)

Command Mode

TOTAL	Measure the power of whole range on the screen
BAND	Measure the power within zone set

11) Set the zone center frequency of channel power measurement

Command: CPCNTR*****
 (*****=Refer to [23.4 Input the frequency])

12) Set the zone width of channel power measurement

Command: CPWIDTH*****
 (*****=Refer to [23.4 Input the frequency])

13) Set the mode of adjacent channel power measurement

Command: ACPMODE*****
 (*****=TOTAL, REF, PEAK)

Command Mode

TOTAL	TOTAL (total power method)
BAND	BAND (in-band method)
PEAK	PEAK (reference level method)

14) Set the band offset of adjacent channel power measurement

Command: ACPOFS*****
 (*****=Refer to [23.4 Input the frequency])

15) Set the bandwidth of adjacent channel power measurement

Command: ACPCHBW*****
 (*****=Refer to [23.4 Input the frequency])

16) Set the reference band center frequency of adjacent channel power measurement

Command: ACPREF*****
 (*****=Refer to [23.4 Input the frequency])

17) Set the reference bandwidth of adjacent channel power measurement

Command: ACPREFBW*****
 (*****=Refer to [23.4 Input the frequency])

18) Set the mode of occupied bandwidth measurement

Command: OBWMODE**
 (**=N%, DB)

Command Mode

N%	N% POWER mode
DB	XdB DOWN mode

19) Set the N% ratio of occupied bandwidth measurement

Command: OBWRATIO*****
 (*****=80.0 to 99.9 [0.1 step, unit: %])

20) Set the XdB down of occupied bandwidth measurement

Command: OBWDB****
 (****=0.1 to 40.0 [0.1 step, unit: dB])

21) Set the antenna of electric field strength measurement

Command: EFANT*****
 (*****=M301, M302, M303, M304, M305, USER)

Command Antenna

M301	Setting date for M301
M302	Setting date for M302
M303	Setting date for M303
M304	Setting date for M304
M305	Setting data for M305
USER	Setting date for user's original antenna

22) Transfer the user-compensation data of electric field strength measurement

Command: EFUSER*****
 Example of the compensation data:
 *****=2.25G:2.08DBI,...2.65G:3.5DBI

If the compensation coefficient is -0.3 dBi at 2.5 GHz, the compensation data is „2.5G:-0.3DBI“

Set apart by „,“ between data and input from lower frequency. 10data are available.

Command Probe

CP2S	Setting data for CP-2S
USER	Setting data for user's original probe

23) Set the probe of magnetic field strength measurement

Command: MFPROBE*****
 (*****=CP2S, USER)

24) Transfer the user-compensation date for magnetic field strength measurement

Command: MFUSER*****
 Example of the compensation data:
 *****=10M:86.7DB, 100M:69.2DB,...3G:40dB

If the compensation coefficient is 86.7 dB at 10 MHz, the compensation data is „10M:86.7DB“: Set apart by „,“ between data and input from lower frequency. 10data are available.

25) Start/Stop Calculation

Command: CALC***
 (***=OFF, MAX, MIN, AVE, OVR)

Command Calculation

OFF	OFF
MAX	MAX HOLD
MIN	MIN HOLD
AVE	AVERAGE
OVR	OVER WRITE

26) Set the number of MAX HOLD

Command: MAXNO*****
 (*****=2, 4, 8, 16, 32, 64, 128, 256, 512, 1024, 0)
 Command: 0 = unlimited

27) Set the number of MIN HOLD

Command: MINNO*****
 (*****=2, 4, 8, 16, 32, 64, 128, 256, 512, 1024, 0)
 Command: 0 = unlimited

RS-232C Interface

28) Set the number of AVERAGE

Command: AVENO***
(*** = 2, 4, 8, 16, 32, 64, 128, 256)

29) Set the display scale of amplitude axis

Command: SCALE**
(** = 2, 10)

Command Display scale

2	2 dB/div
10	10 dB/div

30) Set the sweep time

Command: SWEEP****
(**** = 10M, 30M, 0.1S, 0.3S, 1S, 3S, 10S, 30S, AUTO, ALL)

Command Sweep time

10M	10 ms
30M	30 ms
0.1S	0.1 s
0.3S	0.3 s
1S	1 s
3S	3 s
10S	10 s
30S	30s
AUTO	AUTO
ALL	ALL AUTO

31) Set the detection mode

Command: DET***
(*** = POS, NEG, SMP)

Command Detection mode

POS	Positive peak mode
NEG	Negative peak mode
SMP	Sample mode

32) Request the AUTOTUNE

Command: AUTO

Returns the response after tuning.

33) Request the action

Command: HOLD/RUN

34) Request the marker information

Command: MKRRES

Example of returned data: 1.42G -15dBm

35) Set the marker mode

Command: MKR*****
(***** = NORM, DELTA)

Command Marker mode

NORM	Normal marker
DELTA	Delta marker

36) Set the marker position

Command: NORMMKR*****
(***** = Refer to [23.4 Input the frequency])

37) Set the peak search mode

Command: PEAK****
(**** = NORM, ZONE)

Command Peak search mode

NORM	Normal peak search
ZONE	Zone peak search

38) Request the peak search

Command: PKSEARCH**
(** = 01, 02, 03, 04, 05, 06, 07, 08, 09, 10, 11)

Command Position to where the marker moves

01	Position of the maximum peak on the screen
02	Position of the 2nd highest peak on the screen
...	...
11	Position of the 11th highest peak on the screen

39) Set the zone center frequency of peak search

Command: PKCNTR*****
(***** = Refer to [23.4 Input the frequency])

40) Set the zone width of peak search

Command: PKWIDTH*****
(***** = Refer to [23.4 Input the frequency])

41) Set the unit of marker

Command: CONV***
(*** = DBM, M, DBV, V, DBUVM, VM)

Command Unit of marker

DBM	dBm
W	W
DBV	dBV
V	V
DBUVM	dB μ V/m
VM	V/m

42) Request the transfer of hard copy

Command: PRT

When transferring the returned data to optional printer, hard copy is performed.

43) Request to transfer trace

Command: SRS****
(**** = CURR, 00 to 99)

Command Trace that is transferred

CURR	Trace of Current
00	Trace of save data 1
...	...
99	Trace of save data 100

44) Request to transfer 1001 date of trace

Command: SRSF
(Refer to „22.3 Transfer the data“ about returned data.)

45) Request the preset

Command: PRESET

46) Set the remote control

Command: REMOTE***
 (***=ON, OFF)

When remote control is ON, „REMOTE“ is displayed in the operating information display area on the LCD screen. (Refer to „4. Description Of Screen“ for details)

Command Remote control

ON	Any operation from the keys or the encoder of the main body will not be accepted. Control the unit with RS-232C commands.
OFF	The operation from the keys or the encoder of the main body and RS-232C commands will be accepted.

47) Single sweep

Command: CAPT

It sweeps only once and will be in a HOLD state.

48) Setting of the offset level

Command: OFFSET****
 (****=-50.0 to 50.0 [0.1 step, unit: dB])

49) Setting the input impedance

Command: IMP**
 (**=50, 75)

When selecting of „75Ω“, please attach the coaxial connector (impedance converter) MA301 (optional) to an input connector.

Command Offset level

50	Offset level is set to 0 dB.
75	Offset level is set to 5.7 dB.

50) Clearing of saved trace-data and parameter

Command: MCLR****
 (****=WALL, SALL, W00 to W99, S00 to S99)

It is not clearable with HM5033 main unit.

Command Clearing data

WALL	All of saved trace-data
SALL	All of saved-parameter
W00	Trace-data of save-No. 00
...	...
W99	Trace-data of save-No. 99
S00	Parameter of save-No. 00
...	...
S99	Parameter of save-No. 99

23.4 Input the frequency

For the items written (*****=Refer to [23.4 Input the frequency]) in [23.3 Command description] above, enter a frequency as follows.

***** = 0.0k to 999.9k [0.1 step, unit: Hz]
 0.0M to 999.9M [0.1 step, unit: Hz]
 0.0001G to 3.3G [0.0001 step, unit: Hz]

However, the offset frequency and zone width can be input only in the range decided by the center frequency and frequency span. The value out of the range becomes error. Values of the offset frequency and the zone width will change as you alter the frequency span.

23.5 Writing of original compensation data

On the case of electric field strength measurement used the antenna prepared by the visitor, or, on the case of magnetic field strength measurement used the magnetic field probe prepared by the visitor, it is necessary to write the data of the antenna gain or the magnetic probe field compensation coefficient to HM5033 main unit. Please write the antenna gain or the magnetic probe field compensation coefficient according to the following description. There are two kinds of methods, „method 1: use PC software MAS300 (optional)“ and „method 2: use communication program which is prepared by user“

1) Preparation things

- RS-232C interface cable (9 pole 1:1 Sub-D extension cable)
- Windows® PC (with RS-232C interface)
- It is not writable with HM5033 main unit only.
- PC software MAS300 (case of „Method 1 of writing data“)

2) Write-in data

As example, the compensation data (antenna gain) of antenna M305 and the compensation data (compensation coefficient) of magnetic field probe CP-2S are shown below.

Compensation data (antenna gain) of antenna M305.

Frequency	300 MHz	350 MHz	400 MHz	450 MHz	500 MHz
Antenna gain	0.0 dBi	1.0 dBi	1.4 dBi	1.4 dBi	0.0 dBi

Compensation data (compensation coefficient) of magnetic field probe CP-2S.

Frequency	10 MHz	100 MHz	1 GHz	2 GHz	3 GHz
Compensation coefficient	86.7 dB	69.2 dB	50.7 dB	44.9 dB	40.1 dB

Here, although the number of data is 5 points, it is possible to write even the data of maximum of 10 points. Data cannot be written at 0 Hz.

3) Method 1 of writing data

The method which used the optional PC software MAS300.

Please use MAS300 of the version more than 1.03b. The software can be updated. Please contact to our company for details.

1. Write the antenna gain to text file.

Please create a new text file by new creation of a personal computer, and open by the text editor.

Format

„Frequency“: „Antenna gain“
 „Frequency“: „Antenna gain“
 „Frequency“: „Antenna gain“, ...

Example: case of M305

300M:0.0DB,350M:1.0DB,400M:1.4DB,450M:1.4DB,500M:0.0DB

Please write unit with a capital letter. Moreover, Frequency can also use G (GHz).

2. It writes in by PC software MAS300.

Connect the personal computer to HM5033 by MI180. Turn on the power of HM5033. Start the PC software MAS300. Please set the same baud rate of HM5033 and MAS300. (Refer to „HM5033 operating manual“ for details)

On the case of electric field strength measurement, please choose [File] ! [Write E/F User Data],

on the case of magnetic field strength measurement, please choose [File] ! [Write M/F User Data],

from the upper menu of software, and select the text file which made some time ago.

Then, data is written.

4) Method 2 of writing data

It is method of writing in which does not use MAS300. A user needs to prepare communication program.

1. Prepare the RS-232C communication software.

Connect the personal computer to HM5033. Turn on the power of HM5033. Start the RS-232C communication software.

Please set the same baud rate of HM5033 and software, and unite the setting of communication. (Refer to „22. Data Output“ for details.)

2. Write the data

Please transmit data of the following format to HM5033 from RS-232C communication software.

Format

Case of compensation data of electric field strength measurement.

EFUSER"Frequency": "Antenna gain",
"Frequency": "Antenna gain", ...

Case of compensation data of magnetic field strength measurement.

MFUSER"Frequency": "Compensation coefficient",
"Frequency": "Compensation coefficient", ...

Example: case of CP-2S

MFUSER10M:86.7DB,100M:69.2DB,1G:50.7DB,
2G:44.9DB,3G:40.1DB

Please write unit with a capital letter.

3. After writing is completed correctly

„OK“ is returned from HM5033.

5) How to use

1. Please set the measuring function of HM5033 to electric field strength measurement mode or magnetic field strength measurement mode.

On the case of electric field strength measurement, please select [MEAS] ! [E/F ANT],

on the case of magnetic field strength measurement, please select [MEAS] ! [M/F PROBE],

Please push [F1] and display [USER] on the upper of [F1]. Now, electric field strength measurement or magnetic field strength measurement can be performed by using compensation data written.

Even if a power supply is shut off, the written compensation data does not disappear.

If a power supply is shuts off at once, it will return to the usual measurement.

6) About the antenna gain

In this items, the antenna gain is meaning absolute gain [dBi]. When antenna gain is relative gain, it can change into absolute gain by adding +2.15dB.

Absolute gain [dBi] = Relative gain [dBd] + 2.15dB

As reference, the conversion formula to electric field strength is using the following:

$$E = \sqrt{(480\pi^2 \times Pa \div (Ga \times \lambda^2))}$$

E: Electric field strength [V/m]

Pa: Received electric power [W]

Ga: Antenna gain [times] = $10^{(\text{antenna gain [dBi]} \div 10)}$

λ : Wavelength [m] = $(3 \times 10^8) \div \text{frequency [Hz]}$

23.6 Sample program

An example program to send following setting with RS-232C is shown below.

Setting: Center frequency 1GHz

```
10                               'FREQ SETTING
20  OPEN „COM1:N81N“ AS #1
30  PRINT #1 „FREQ1G“;          „FREQ1G“ OUTPUT
40  INPUT #1 A$                  „OK“ READ
50  CLOSE #1
```

24. PC Software (optional)

This is the software MAS300 that controls HM5033 by RS-232C. All setting can be performed from PC. Although the 251 points of trace data is displayed on horizontal axis in the screen of the HM5033, 1001 points of trace data are taken per sweep. When this software is used, all of these 1001 points data are transformed to a PC and trace is displayed at high resolution.

Corresponding OS

Hardware Requirements

Computer that is able to act normally Windows®, and able to use the COM port and CD-ROM drive.
Screen size 1024x768 or more computers.

Operating system

Windows® 95/98/2000/Me/NT

XP: Only the check of operation is performed.

Communication method

Bidirectional communication by RS-232C.

Installation procedure

1. Start windows®.
2. Insert the MAS300 software CD into the CD-ROM drive. The setup will start automatically and the initial screen will appear.
3. Follow the instructions on the screen.

If the setup does not start,

1. Double-click on the My Computer icon.
2. Double-click on the CD-ROM icon.
3. Double-click on „setup.exe“.
4. Follow the instructions on the screen.

Refer to the „REEDME“ in the HM5033 for details.

The software can be updated. Please contact to our company for details.

25. Basis Performance Test

To keep the quality of the unit, regular performance testing is recommended. This section describes a method and specification of basic performance testing. If a problem is found in the results of basic performance testing, or formal testing is needed, please contact the dealership where you purchased the product, or contact us.

[Connection diagram]

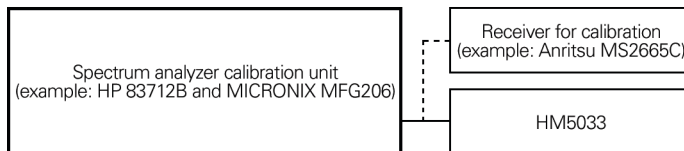

25.1 Frequency characteristics

Adjust the output level of the spectrum analyzer calibration unit (thereafter, „calibration unit“) so that the displayed power value is -15dBm at each frequency for this unit, and measure the absolute value with a receiver for calibration (microwave power meter, etc.).

Setting of HM5033			Specifications	Measurement value	Judgement
Centerfrequency	Frequency span	RBW			
50 kHz	200 kHz	10 kHz	within Reference ± 2.6 dB ± 1 dot		
100 kHz	200 kHz	30 kHz	within Reference ± 2.6 dB ± 1 dot		
1 MHz	2 MHz	100 kHz	within Reference ± 1.6 dB ± 1 dot		
10 MHz	10 MHz	3 MHz	within Reference ± 1.0 dB ± 1 dot		
100 MHz	10 MHz	3 MHz	Reference		
1 GHz	10 MHz	3 MHz	within Reference ± 1.0 dB ± 1 dot		
2 GHz	10 MHz	3 MHz	within Reference ± 1.0 dB ± 1 dot		
3.3 GHz	10 MHz	3 MHz	within Reference ± 1.0 dB ± 1 dot		

RBW switching error is included at RBW other than 3MHz.

Basic Performance Test

Setting of HM5033

Reference level: -15 dBm
VBW: 1 MHz
Sweep time: 1 s
Detection mode: SMPL
Display scale: 2 dB/div

Setting of calibration unit

Frequency: Same as a center frequency of HM5033
Output power: Adjust the power indication of HM5033 to -15 dBm.

25.2 Accuracy of reference level

Adjust the output level of the calibration unit so that the displayed value of this unit is the 0th div from the top, and calibrate the absolute value with the receiver for calibration (microwave power meter, etc.).

Setting of HM5033 Reference level	Specifications	Measurement value	Judgement
+10 dBm	within ± 1.4 dB ± 1 dot		
0 dBm	within ± 1.4 dB ± 1 dot		
-10 dBm	within ± 1.4 dB ± 1 dot		
-15 dBm	within ± 0.8 dB ± 1 dot		
-20 dBm	within ± 1.4 dB ± 1 dot		
-30 dBm	within ± 1.4 dB ± 1 dot		
-40 dBm	within ± 1.4 dB ± 1 dot		

Input attenuator switching error is included at the reference level other than -15 dBm.

Setting of HM5033

Center frequency: 100 MHz
Frequency span: 10 MHz
RBW: 3 MHz
VBW: 1 MHz
Sweep time: 1 s
Detection mode: SMPL
Display scale: 2 dB/div

Setting of calibration unit

Frequency: 100 MHz
Output power: Adjust it so that the indicated value of HM5033 is at the 0th div from the top.

25.3 The display accuracy of the center frequency

Measure the frequency with the peak search function of HM5033.

Setting of HM5033			Specifications	Measurement value	Judgement
Center frequency	Frequency span	RBW			
100 MHz	200 kHz	3 kHz	within ± 130 kHz ± 1 dot		
100 MHz	10 MHz	30 kHz	within ± 130 kHz ± 1 dot		
100 MHz	20 MHz	100 kHz	within ± 800 kHz ± 1 dot		
100 MHz	200 MHz	100 kHz	within ± 800 kHz ± 1 dot		
1 GHz	500 MHz	100 kHz	within ± 800 kHz ± 1 dot		
1 GHz	2 GHz	3 MHz	within ± 800 kHz ± 1 dot		
1.65 GHz	FULL (3.3 GHz)	3 MHz	within ± 800 kHz ± 1 dot		

Setting of HM5033

Reference level: -15 dBm
 VBW: AUTO
 Sweep time: 1 s
 Detection mode: SMPL
 Display scale: 10 dB/div

Setting of calibration unit

Frequency: Same as a center frequency of HM5033.
 Output power: -15 dBm

However, calibrate the signal generator in advance.

25.4 The display accuracy of the frequency span

Adjust the frequency of the calibration equipment so that the peaks are at the positions of f_1 and f_9 , and measure the frequencies of f_1 and f_9 . Calculate from f_1 and f_9 the display accuracy of the frequency span.

Setting of HM5033			Specifications	f_1 Measurement value	f_9 Measurement value	$(f_9 - f_1)$ X 1.25	Judgement
Frequency span	Center Frequency	RBW					
200 kHz	100 MHz	3 kHz	within ± 26 kHz ± 1 dot				
10 MHz	100 MHz	100 kHz	within ± 320 kHz ± 1 dot				
20 MHz	100 MHz	300 kHz	within ± 0.8 MHz ± 1 dot				
200 MHz	100 MHz	3 MHz	within ± 6.2 MHz ± 1 dot				
500 MHz	1 GHz	3 MHz	within ± 15.2 MHz ± 1 dot				
2 GHz	1 GHz	3 MHz	within ± 60.2 MHz ± 1 dot				
FULL (3.3 GHz)	1.65 GHz	3 MHz	within ± 99.2 MHz ± 1 dot				

f_1 : 1st div from the left on the trace screen / f_9 : 9th div from the left on the trace screen

Basic Performance Test

Setting of HM5033

Reference level: -15 dBm
 VBW: AUTO
 Sweep time: 1 s
 Detection mode: SMPL
 Display scale: 2 dB/div

Setting of calibration unit

Frequency: Adjust it to the positions of f_1 and f_9 .
 Output power: -15 dBm

25.5 Linearity of the amplitude axis

Adjust the level of the calibration unit so that the peak is at the top of the amplitude axis (0th div), and regard the point set at that time as the reference. Gradually lower the output, starting from the reference, and measure the amplitude value of HM5033.

Setting of HM5033				
Display scales	Output of calibration unit	Specifications	Measurement value	Judgement
10 dB/div	XdBm (adjust it to the 0th div)	Reference (-15 dBm)	(-15 dBm)	
	X-10 dBm	within $-25 \text{ dBm} \pm 0.8 \text{ dB} \pm 1 \text{ dot}$		
	X-70 dBm	within $-85 \text{ dBm} \pm 1.6 \text{ dB} \pm 1 \text{ dot}$		
2 dB/div	XdBm (adjust it to the 0th div)	Reference (-15 dBm)	(-15 dBm)	
	X-2 dB	within $-17 \text{ dBm} \pm 0.2 \text{ dB} \pm 1 \text{ dot}$		
	X-10 dB	within $-25 \text{ dBm} \pm 0.8 \text{ dB} \pm 1 \text{ dot}$		

Setting of HM5033

Center frequency: 100 MHz
 Reference level: -15 dBm
 Frequency span: 10 MHz
 RBW: 3 MHz
 VBW: 1 MHz
 Sweep time: 1 s
 Detection mode: SMPL

Setting of calibration unit

Frequency: 100 MHz







HAMEG[®] **Instruments**

Oscilloscopes

Multimeters

Counters

Frequency Synthesizers

Generators

R- and LC-Meters

Spectrum Analyzers

Power Supplies

Curve Tracers

Time Standards

42-5033-00E0

HAMEG GmbH

Industriestraße 6

D-63533 Mainhausen

Tel.: ++49 (0) 61 82 89 09-0

Fax: ++49 (0) 61 82 89 09-30

E-mail: sales@hameg.de

Internet:
www.hameg.de

Printed in Germany